

Book Print

This page intentionally left blank

Contents

P-592-A - INDEX OF SUB ASSEMBLIES	5
P-592-C - FRONT PANEL ASSEMBLY	8
P-592-D - CONTROL BOX ASSEMBLY.....	13
P-592-E - SPINDLE & MAST ASSEMBLY.....	22
P-592-F - WIRE DRIVE ASSEMBLY	27
P-592-G - CASE ASSEMBLY	36

P-592-A - INDEX OF SUB ASSEMBLIES



P-592-A
INDEX OF SUB ASSEMBLIES

Количество: 1

1



P-592-C
FRONT PANEL ASSEMBLY

Количество: 1

2



P-592-D
CONTROL BOX ASSEMBLY

Количество: 1

3



P-592-E
SPINDLE & MAST ASSEMBLY

Количество: 1

4



P-592-F
WIRE DRIVE ASSEMBLY

Количество: 1

5



P-592-G
CASE ASSEMBLY

Количество: 1

P-592-A - INDEX OF SUB ASSEMBLIES



P-592-A
INDEX OF SUB ASSEMBLIES

Количество: 1

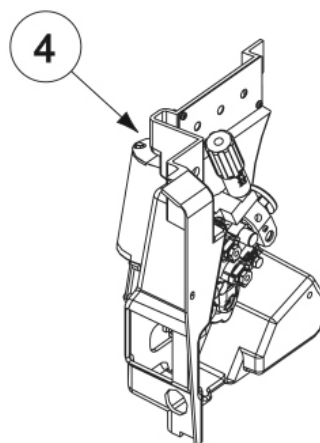
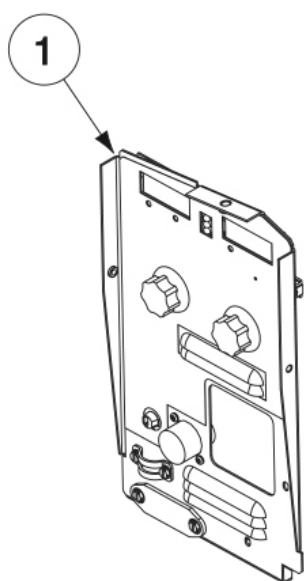
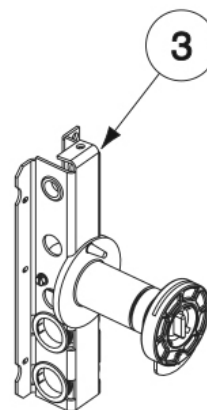
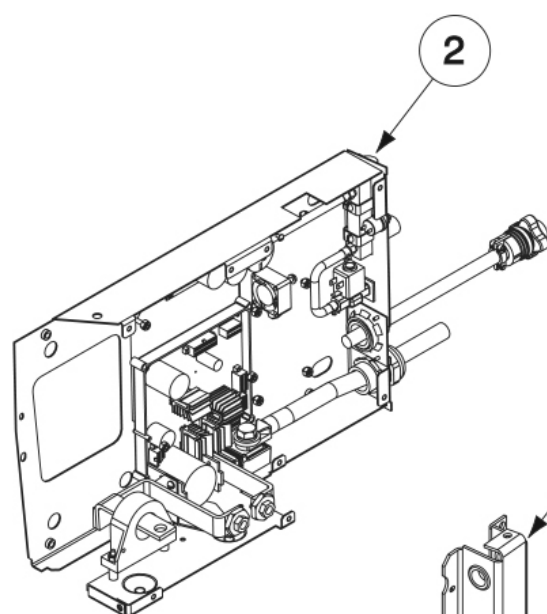
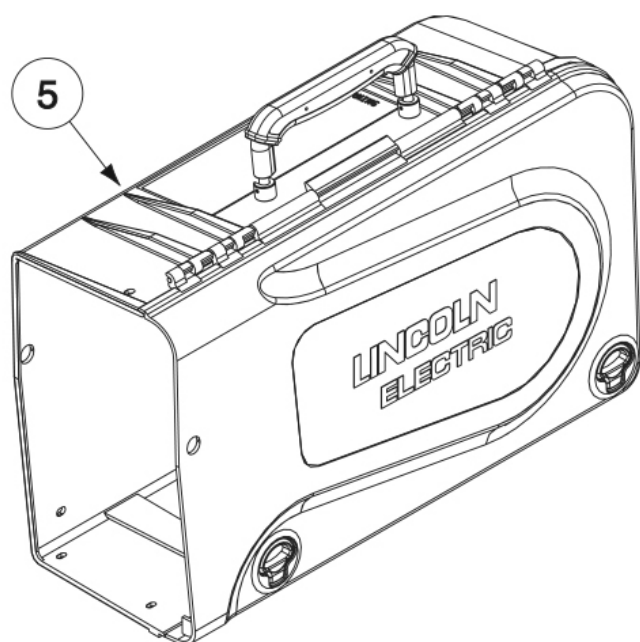

P-592-A - INDEX OF SUB ASSEMBLIES













P-592-A
INDEX OF SUB ASSEMBLIES

Количество: 1











Лист: P-592-A.jpg

<x-wc://file=P-592-A.jpg> / [P-592-A_en-US.jpg](x-wc://file=P-592-A_en-US.jpg)











P-592-C - FRONT PANEL ASSEMBLY

		P-592-C FRONT PANEL ASSEMBLY	Количество: 1
		9SG6320 FRONT PANEL ASSEMBLY	Количество: 1
1		9SG5578 CASE FRONT DIGITAL	Количество: 1
2		9SL13090 DIGITAL DISPLAY NAMEPLATE	Количество: 1
3A		9SG4749-1 PRESET PC BD ASBLY	Количество: 1
3B		9ST10082-12 #6-32 X .25 SEMS SCREW	Количество: 4
		9SL13084 CONNECTOR & LEAD ASBLY	Количество: 1
4A		9SS12021-66 BOX RECEPTACLE SOLID SHELL	Заменена Количество: 1
4B		9ST10812-119 POTENTIOMETER	Заменена Количество: 1
4C		9SS18280 POTENTIOMETER SPACER	Количество: 1

P-592-C - FRONT PANEL ASSEMBLY

		P-592-C FRONT PANEL ASSEMBLY	Количество: 1
		9SS8025-113 SELF TAPPING SCREW	Количество: 2
5		9ST10491 KNOB	Количество: 2
		9SM21286 REMOTE VOLTAGE CONTROL ASBLY	Количество: 1
6A		9ST10812-119 POTENTIOMETER	Заменена Количество: 1
6B		9SS18280 POTENTIOMETER SPACER	Количество: 1
7A		9SM17894 WATER INLET / OUTLET COVER	Количество: 1
7B		9SCF000401 #10-24 X .50 HHCS	Количество: 2
8A		9ST13637-5 DIODE BRIDGE, 35A 800V	Заменена Количество: 2
8B		9ST9187-13 1/4-20 HLN	Количество: 2

P-592-C - FRONT PANEL ASSEMBLY

		P-592-C FRONT PANEL ASSEMBLY	Количество: 1
9		9ST9274-5 GROMMET	Количество: 1
		9SS17211-5 GROUND LEAD ASBLY	Заменена Количество: 1
12A		9SS24287 STRAIN RELIEF CLAMP	Количество: 1
12B		9SCF000401 #10-24 X .50 HHCS	Количество: 2
		9SS9225-4 THREAD FORMING SCREW	Заменена Количество: 2
20A		9SCF000401 #10-24 X .50 HHCS	Количество: 1
20B		9SS9262-27 PLAIN WASHER	Количество: 1
20C		9ST9187-13 1/4-20 HLN	Количество: 1
21		9SCF000401 #10-24 X .50 HHCS	Количество: 1

P-592-C - FRONT PANEL ASSEMBLY



P-592-C
FRONT PANEL ASSEMBLY

Количество: 1

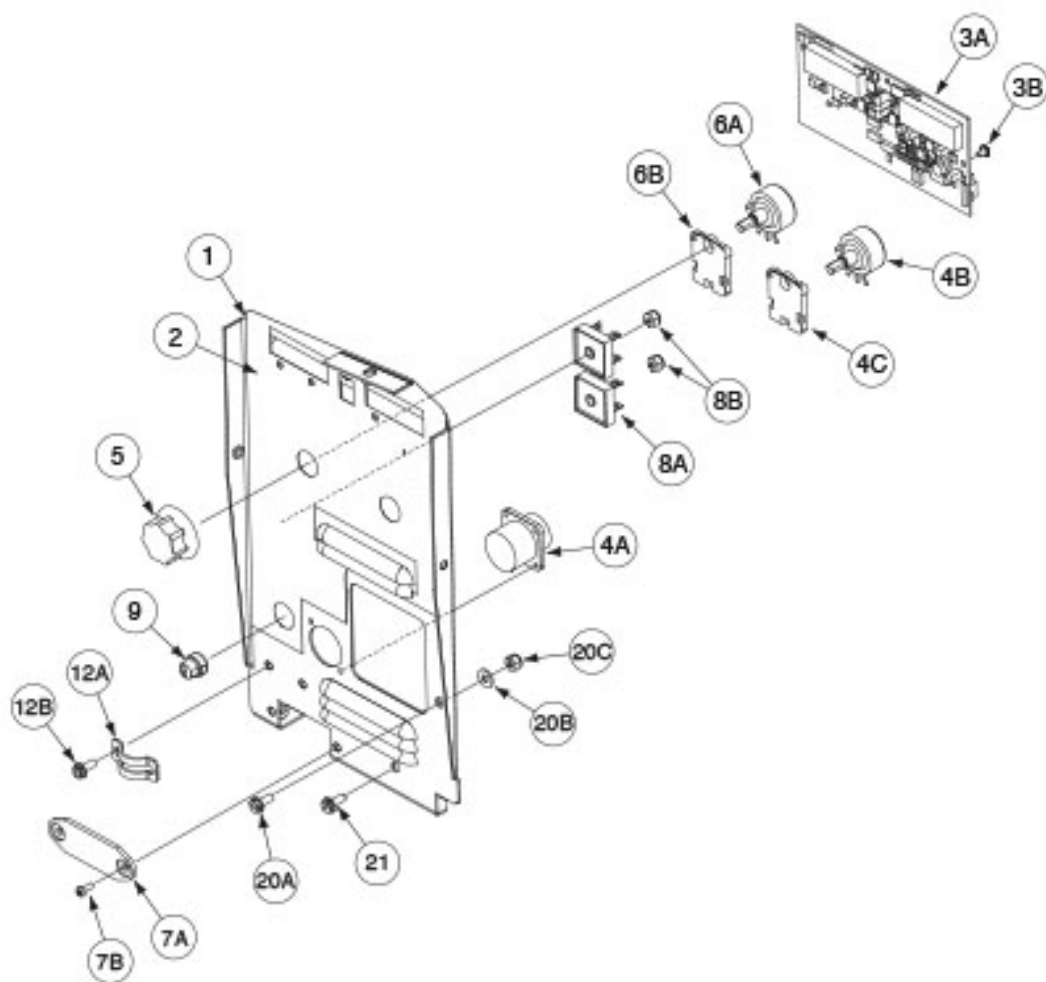

P-592-C - FRONT PANEL ASSEMBLY













P-592-C
FRONT PANEL ASSEMBLY

Количество: 1











Лист: P-592-C.jpg

<x-wc://file=P-592-C.jpg> / P-592-C_en-US.jpg











P-592-D - CONTROL BOX ASSEMBLY

		P-592-D CONTROL BOX ASSEMBLY		Количество: 1
		9SG6318-1 CONTOL BOX ASBLY		Количество: 1
1		9SG5584-1 CONTROL BOX	Заменена	Количество: 1
2A		9SS28010-4 FLEXIBLE POWER PC BD ASBLY	Заменена	Количество: 1
2B		9ST9187-13 1/4-20 HLN		Количество: 4
3A		9SS18504-6 CURRENT TRANSDUCER LINEAR		Количество: 1
3B		9ST7028-181 INSULATING TUBE		Количество: 2
3C		9SCF000122 #10-24X1.50 RHS		Количество: 2
3D		9ST9187-13 1/4-20 HLN		Количество: 2
4A		9SS26587-1 CONTROL BOX PANEL		Количество: 1











P-592-D - CONTROL BOX ASSEMBLY

		P-592-D CONTROL BOX ASSEMBLY	Количество: 1
4B		9SM21275 CABLE CONNECTOR ASBLY	Количество: 1
4C		9SS8025-113 SELF TAPPING SCREW	Количество: 4
5A		9SS25565-2 GAS FLOW METER ASBLY	Количество: 1
		9SE106A-1 LOCK WASHER	Количество: 2
6A		9ST10642-265 GAS HOSE	Количество: 1
		9ST13777-8 HOSE CLAMP	Количество: 2
7A		9SG5572-1 SPINDLE MAST ASBLY	Количество: 1
7B		9ST9187-13 1/4-20 HLN	Количество: 6
8A		9SM21096 INSULATED MOUNTING BLOCK	Количество: 1











P-592-D - CONTROL BOX ASSEMBLY

		P-592-D CONTROL BOX ASSEMBLY	Количество: 1
		9SCF000401 #10-24 X .50 HHCS	Количество: 2
		9SCF000027 1/2-13HN	Количество: 1
10B		9SS9262-80 PLAIN WASHER	Количество: 1
10C		9SE106A-15 LOCKWASHER	Количество: 1
10D		9SCF000052 1/2-13 HHCS	Количество: 1
		9SL12936-1 CONTACTOR ASSEMBLY	Заменена Количество: 1
11A		9SM15308-6 CONTACTOR	Заменена Количество: 1
11B		9SM21094-1 CONTACTOR BRACKET	Количество: 1
		9ST14731-67 METRIC PAN HEAD SCREW	Количество: 2











P-592-D - CONTROL BOX ASSEMBLY

		P-592-D CONTROL BOX ASSEMBLY	Количество: 1
		9SE106A-1 LOCK WASHER	Количество: 2
11E		9SM21010 BUS BAR ASSEMBLY	Количество: 1
11F		9SM21005 BUS BAR ASSEMBLY	Количество: 1
11G		9ST9860-4 LOCK WASHER	Количество: 2
		9ST15088 INSULATED FASTENER	Количество: 1
		9SS9262-98 PLAIN WASHER	Количество: 2
11K		9SCF000401 #10-24 X .50 HHCS	Количество: 2
		9SM21463-1 WELD CABLE	Количество: 1
12A		9SS19999 CORD GRIP CONNECTOR	Количество: 1







P-592-D - CONTROL BOX ASSEMBLY

		P-592-D CONTROL BOX ASSEMBLY		Количество: 1
12B		K852-95 WELDING CABLE PLUG KIT (2/0-3/0)	Заменена	Количество: 1
		9ST14370-3 CONDUIT LOCKNUT		Количество: 1
		9SG5682-2 WIRING HARNESS	Заменена	Количество: 1
14A		9SS26807 PUSH BUTTON SWITCH		Количество: 1
15A		9SM17294-8 12 VDC SOLENOID VALVE ASSEMBLY	Заменена	Количество: 1
		9SS9262-149 PLAIN WASHER		Количество: 1
		9ST14370-1 CONDUIT LOCKNUT		Количество: 1
16A		9ST10642-262 FLEX TUBE		Количество: 1
		9ST13777-8 HOSE CLAMP		Количество: 2

P-592-D - CONTROL BOX ASSEMBLY

		P-592-D CONTROL BOX ASSEMBLY	Количество: 1
		9SL13051 DECAL	Количество: 1
18A		9SS27028 FAN ASSEMBLY	Количество: 1
		9SS8025-108 SELF TAPPING SCREW	Количество: 2
21A		9SS27506-1 MOTOR FILTER PC BOARD ASSEMBLY	Количество: 1
21B		9ST10082-12 #6-32 X .25 SEMS SCREW	Количество: 4
		9SM21926 PLUG AND LEAD ASBLY	Количество: 1
		9SS22969-11 BYPASS JUMPER ASBLY	Количество: 1
		9SCF000010 #10-24HN-4265	Количество: 2
		9SE106A-1 LOCK WASHER	Количество: 1

P-592-D - CONTROL BOX ASSEMBLY

		P-592-D CONTROL BOX ASSEMBLY	Количество: 1
25A		9SM21011-2 CONTROL BOX COVER	Количество: 1
25B		9SCF000401 #10-24 X .50 HHCS	Количество: 4
25B		9SS9225-36 THREAD FORMING SCREW	Заменена Количество: 4
25C		9ST14882-2 DOOR BUMPER	Количество: 4

P-592-D - CONTROL BOX ASSEMBLY



P-592-D
CONTROL BOX ASSEMBLY

Количество: 1

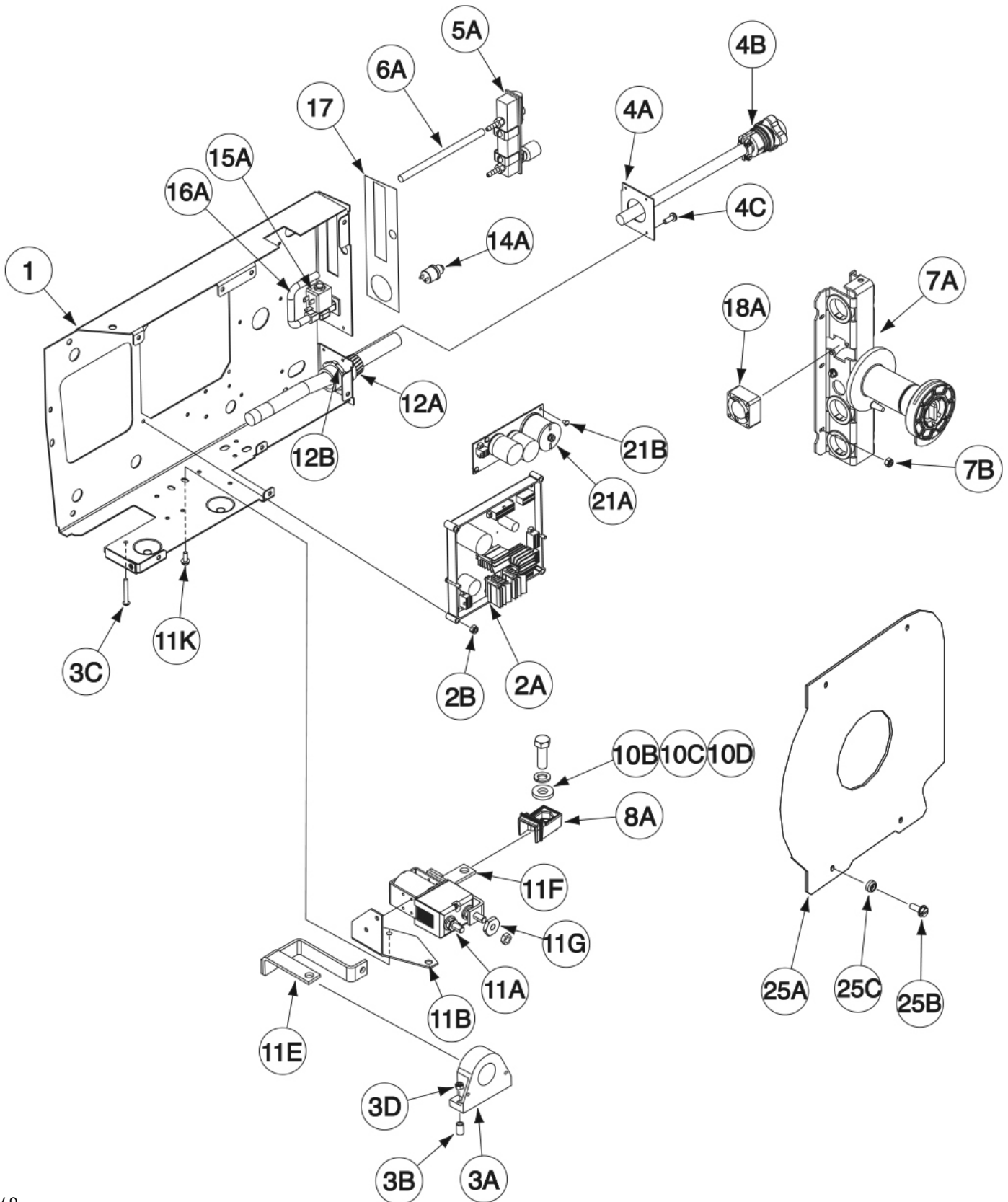

P-592-D - CONTROL BOX ASSEMBLY













P-592-D
CONTROL BOX ASSEMBLY

Количество: 1











Лист: P-592-D.jpg

[x-wc://file=P-592-D.jpg / P-592-D_en-US.jpg](#)











P-592-E - SPINDLE & MAST ASSEMBLY

		P-592-E SPINDLE & MAST ASSEMBLY	Количество: 1
		9SG5572-1 SPINDLE MAST ASBLY	Количество: 1
1		9SG5571-1 SPINDLE MAST	Количество: 1
2		9SM20990-1 SPINDLE SHAFT	Количество: 1
3A		9SS9225-93 THREAD FORMING SCREWROLLING(1/4-20X.38)	Заменена Количество: 2
3B		9ST9860-6 EXTERNAL TOOTH LOCK WASHER	Количество: 2
5		9ST12380-1 BUSHING	Количество: 4
7		9SL10560-2 SPINDLE	Количество: 1
8		9SS17435-3 FRICTION WASHER	Количество: 2
9		9ST12965-2 KEYED WASHER	Количество: 1

P-592-E - SPINDLE & MAST ASSEMBLY

		P-592-E SPINDLE & MAST ASSEMBLY	Количество: 1
10		9ST11862-14 SPRING	Количество: 1
11		9ST14813-A THUMB SCREW	Количество: 1
12		9SS23811 RETAINING COLLAR ASSEMBLY	Количество: 1
15		9ST12380-1 BUSHING	Количество: 2
		9SG5572-1 SPINDLE MAST ASBLY	Количество: 1
1		9SG5571-1 SPINDLE MAST	Количество: 1
2		9SM20990-1 SPINDLE SHAFT	Количество: 1
3A		9SS9225-93 THREAD FORMING SCREWROLLING(1/4-20X.38)	Заменена Количество: 2
3B		9ST9860-6 EXTERNAL TOOTH LOCK WASHER	Количество: 2

P-592-E - SPINDLE & MAST ASSEMBLY

		P-592-E SPINDLE & MAST ASSEMBLY	Количество: 1
5		9ST12380-1 BUSHING	Количество: 4
7		9SL10560-2 SPINDLE	Количество: 1
8		9SS17435-3 FRICTION WASHER	Количество: 2
9		9ST12965-2 KEYED WASHER	Количество: 1
10		9ST11862-14 SPRING	Количество: 1
11		9ST14813-A THUMB SCREW	Количество: 1
12		9SS23811 RETAINING COLLAR ASSEMBLY	Количество: 1
15		9ST12380-1 BUSHING	Количество: 2

P-592-E - SPINDLE & MAST ASSEMBLY



P-592-E
SPINDLE & MAST ASSEMBLY

Количество: 1

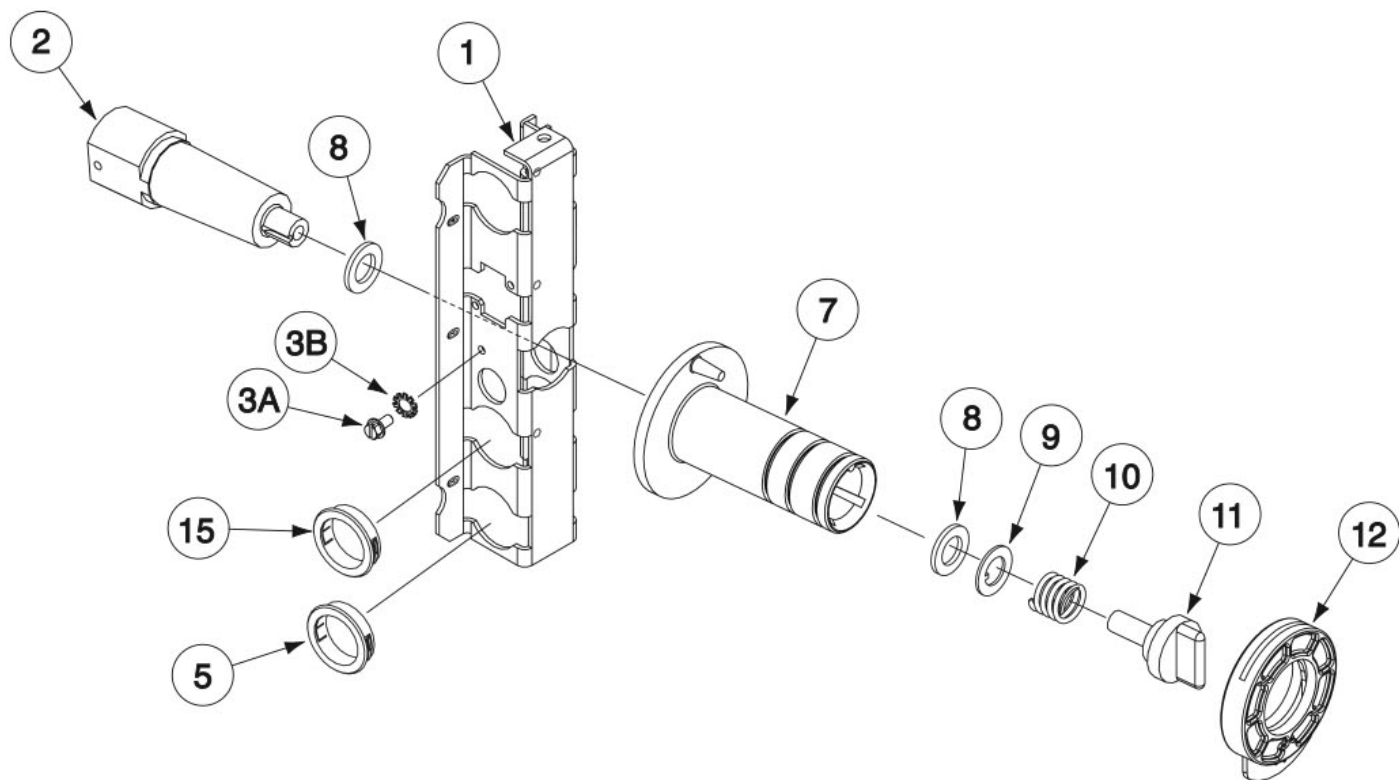

P-592-E - SPINDLE & MAST ASSEMBLY













P-592-E
SPINDLE & MAST ASSEMBLY

Количество: 1











Лист: P-592-E.jpg

[x-wc://file=P-592-E.jpg / P-592-E_en-US.jpg](#)











P-592-F - WIRE DRIVE ASSEMBLY

		P-592-F WIRE DRIVE ASSEMBLY		Количество: 1
		9SM21079-7 WIRE DRIVE ASSEMBLY	Заменена	Количество: 1
1		9SG5569 WIRE DRIVE PANEL	Заменена	Количество: 1
		9SM19932 FEEDPLATE ASSEMBLY		Количество: 1
2B		9SM19611-1 CONNECTION BAR		Количество: 1
2C		9ST9447-112 SOCKET HEAD CAP SCREW		Количество: 1
2D		9SS9262-167 PLAIN WASHER		Количество: 1
2E		9SS9776-69 RETAINING RING		Количество: 1
2F		9SL10546-2 IDLE ARM		Количество: 1
		9ST13942-14 DOWEL PIN		Количество: 1











P-592-F - WIRE DRIVE ASSEMBLY

		P-592-F WIRE DRIVE ASSEMBLY	Количество: 1
2H		9SM19179-1 ADJUSTMENT ARM ASBLY	Заменена Количество: 1
		9ST9967-35 PIN	Количество: 2
		9SS22672 WIRE GUIDE RETAINING PIN	Количество: 2
2L		9SS25402 SHAFT	Количество: 2
		9SS11604-47 SET SCREW	Количество: 1
3A		9SCF000112 3/8-16X1.75HHCS	Количество: 4
3B		9SE106A-2 LOCK WASHER	Количество: 4
3C		9SS9262-23 PLAIN WASHER	Количество: 4
4A		9SL12081-1 MOTOR GEARBOX	Заменена Количество: 1











P-592-F - WIRE DRIVE ASSEMBLY

		P-592-F WIRE DRIVE ASSEMBLY	Количество: 1
		9SS24018-8 CONNECTOR,MOLEX,MINI,LDS,8-PIN	Количество: 1
		9SS24019-8 CONNECTOR,LOCKING POST,FOR 8-CAVITY	Количество: 1
4E		9SS24170-1 WOODRUFF KEY	Количество: 1
4F		9SS9776-27 RETAINING RING	Количество: 1
		9SE106A-2 LOCK WASHER	Количество: 3
		9SS28460 MOTOR BRUSH & BRUSH CAP	Количество: 1
		9ST14731-18 M6 X 1.00 PPNHS	Количество: 3
6A		9SM19870 DRIVE GEAR	Количество: 1
6B		9SS25414 COLLAR	Количество: 1











P-592-F - WIRE DRIVE ASSEMBLY

		P-592-F WIRE DRIVE ASSEMBLY	Количество: 1
6C		9ST4291-A LOCK WASHER	Количество: 1
6D		9ST14731-47 METRIC SCREW	Количество: 1
7A		9SM19999 COVER	Количество: 1
7B		9SCF000012 1/4-20X.50HHCS	Количество: 1
7C		9SE106A-2 LOCK WASHER	Количество: 1
8		9SS25638 DRIVE ROLL SHAFT ASSEMBLY	Заменена Количество: 2
8A		9SS25308 TWIST LOCK RING	Количество: 2
9		9SS25403 RETAINER	Количество: 2
10		KP2071-3 OUTER WIRE GUIDE ASBLY	Заменена Количество: 1

P-592-F - WIRE DRIVE ASSEMBLY

		P-592-F WIRE DRIVE ASSEMBLY	Количество: 1
13		9SM18946 BALL HOUSING	Количество: 1
14		9SS11604-21 SET SCREW	Количество: 1
15A		9SS25706 TIMER KIT PANEL	Количество: 1
15B		9ST14659-3 FASTENER BUTTON	Количество: 2
18		9SS9225-36 THREAD FORMING SCREW	Заменена Количество: 4
		9ST14882-2 DOOR BUMPER	Количество: 4
19A		9SCF000021 1/2-13X1.00HHCS	Количество: 1
19B		9SE106A-15 LOCKWASHER	Количество: 1
19C		9SS9262-80 PLAIN WASHER	Количество: 1

P-592-F - WIRE DRIVE ASSEMBLY

		P-592-F WIRE DRIVE ASSEMBLY	Количество: 1
25		9SL13051 DECAL	Количество: 1
26		9SL13051 DECAL	Количество: 1
27		9SL13051 DECAL	Количество: 1
28		9ST10800-38 SWITCH TOGGLE	Заменена Количество: 2
		9SS26310 DECAL	Количество: 1
30		9SS22905-2 GUN ADAPTER ASSEMBLY	Количество: 1
31		9ST13858 MOLDED HAND SCREW	Количество: 1
		9SL13057 PLUG AND LEAD ASBLY	Количество: 1
32A		9SS26807 PUSH BUTTON SWITCH	Количество: 1

P-592-F - WIRE DRIVE ASSEMBLY



P-592-F
WIRE DRIVE ASSEMBLY

Количество: 1



9SS25890-1
DECAL, PRESSURE ARM

Количество: 1



9SS22774-1
GUN ADAPTER BUSHING

Количество: 1



9SS9225-36
THREAD FORMING SCREW

Заменена

Количество: 4

P-592-F - WIRE DRIVE ASSEMBLY



P-592-F
WIRE DRIVE ASSEMBLY

Количество: 1

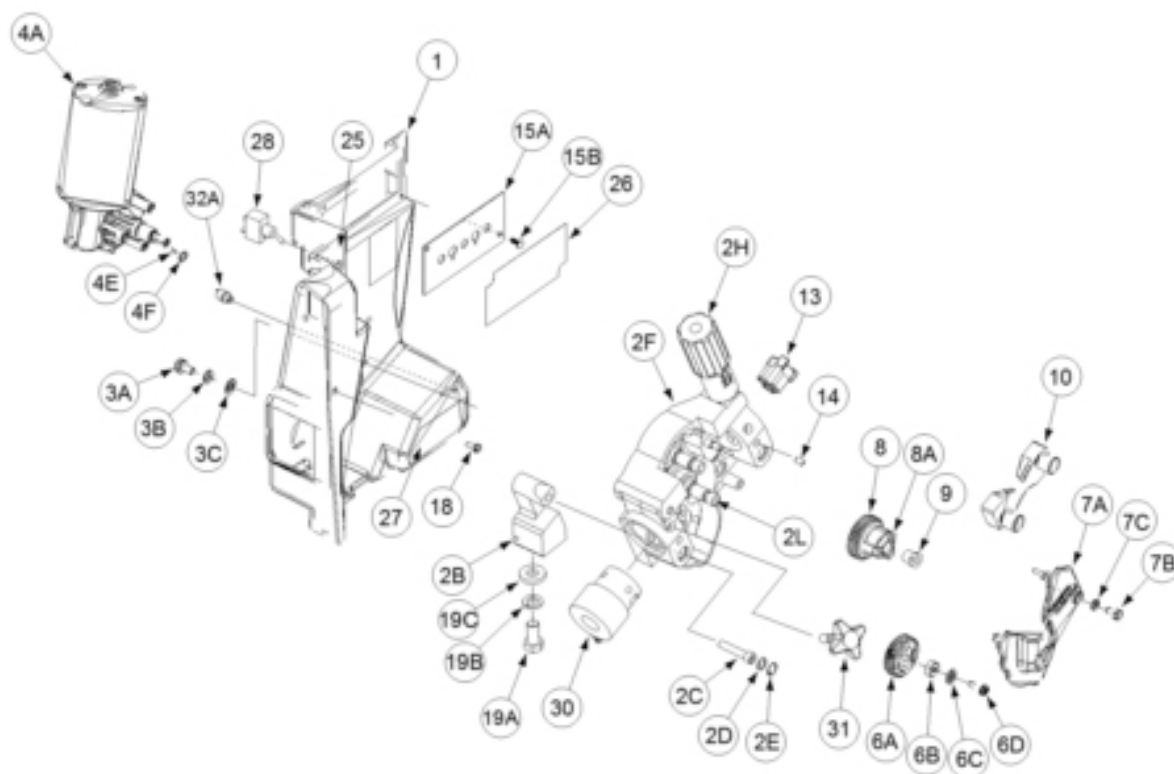

P-592-F - WIRE DRIVE ASSEMBLY













P-592-F
WIRE DRIVE ASSEMBLY

Количество: 1











Лист: P-592-F.jpg

[x-wc://file=P-592-F.jpg / P-592-F_en-US.jpg](#)

P-592-G - CASE ASSEMBLY

		P-592-G CASE ASSEMBLY	Количество: 1
		9SG5661 CASE ASSEMBLY	Количество: 1
1A		9SG5660 CASE ASSEMBLY PLASTIC	Количество: 1
1B		9SM20977-1 LATCH	Количество: 1
2A		9SS18170 HANDLE ASSEMBLY	Количество: 1
2B		9SS9262-47 PLAIN WASHER	Количество: 2
		9SCF000170 1/4-20X.375HNB	Количество: 2
4A		9SS20601-2 WARNING DECAL	Количество: 1
4B		9SS20601-2 WARNING DECAL	Количество: 1
5		9SS11893-9 CASE LOGO DECAL	Количество: 1

P-592-G - CASE ASSEMBLY

		P-592-G CASE ASSEMBLY	Количество: 1
6		9SS25536-1 WARNING DECAL	Количество: 1
8		9ST13086-186 DECAL	Количество: 1
9		9SS11893-8 DOOR LOGO DECAL	Количество: 1
		9ST13086-201 DECAL	Количество: 1
12		9ST10397-6 PLUG BUTTON	Количество: 2
13		9ST10397-19 PLUG BUTTON	Количество: 2
		9SS26924 GASKET	Количество: 1
20		9SS9225-93 THREAD FORMING SCREWROLLING(1/4-20X.38)	Заменена Количество: 8
		9SM15242-2 DECAL	Количество: 1

P-592-G - CASE ASSEMBLY



P-592-G
CASE ASSEMBLY

Количество: 1



9SG6334
WIRING DIAGRAM

Количество: 1



9SL13090
DIGITAL DISPLAY NAMEPLATE

Количество: 1



9SS24017-10
MOLEX HOUSING

Количество: 1

P-592-G - CASE ASSEMBLY



P-592-G
CASE ASSEMBLY

Количество: 1

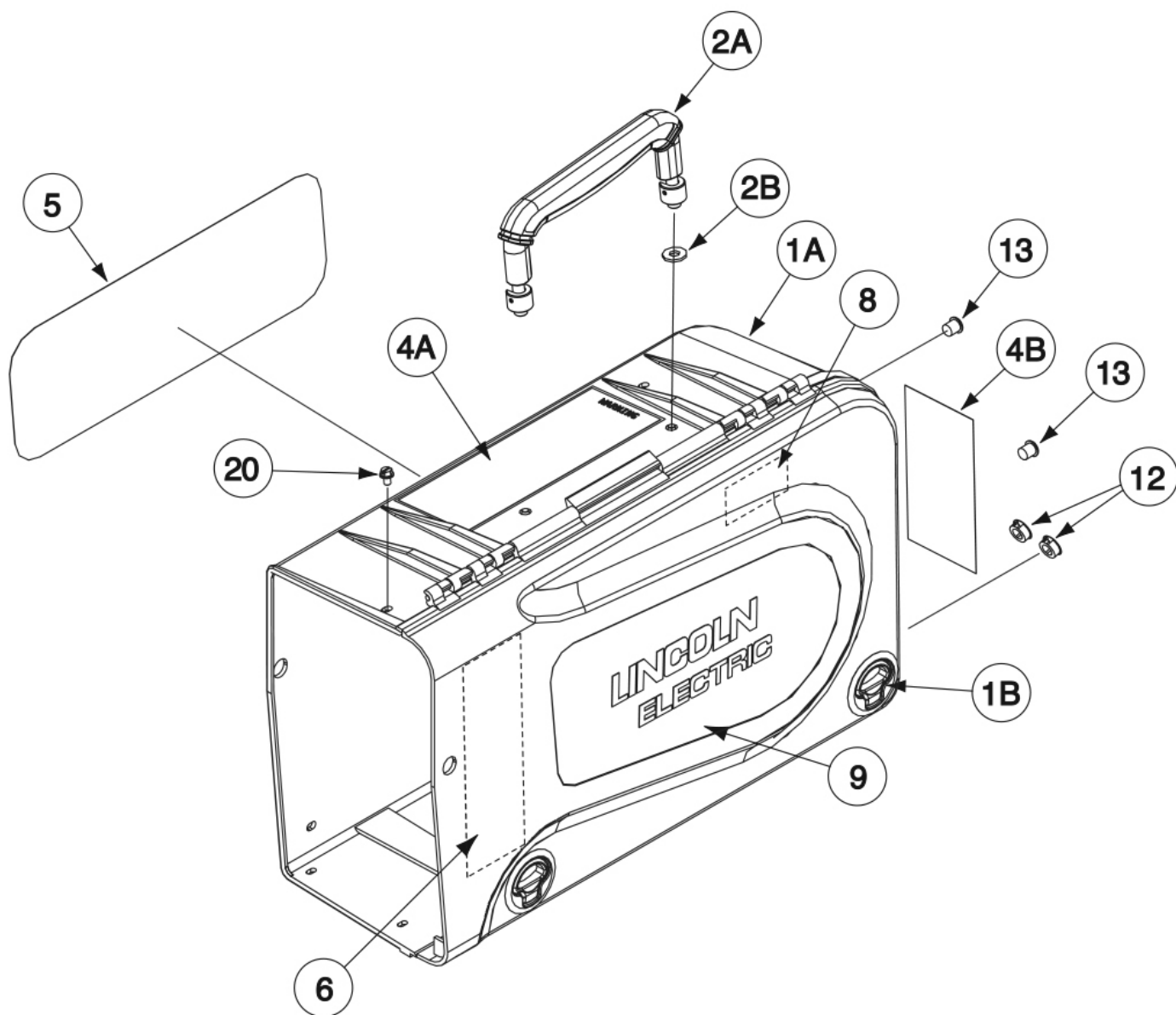

P-592-G - CASE ASSEMBLY



P-592-G
CASE ASSEMBLY

Количество: 1

Лист: P-592-G.jpg

[x-wc://file=P-592-G.jpg / P-592-G_en-US.jpg](#)