

# Book Print

This page intentionally left blank

# Contents

P-518-A - INDEX OF SUB ASSEMBLIES .....	5
P-518-B.2 - MISCELLANEOUS ITEMS .....	8
P-518-C - CONTROL BOX/CENTER PANEL/CASE SHELL ASSE.....	9
P-518-D - WIRE DRIVE ASSEMBLY .....	18



# P-518-A - INDEX OF SUB ASSEMBLIES

---



P-518-A  
INDEX OF SUB ASSEMBLIES

Количество: 1

---



P-518-B.2  
MISCELLANEOUS ITEMS

Количество: 1

---

1



P-518-C  
CONTROL BOX/CENTER PANEL/CASE SHELL ASSE

Количество: 1

---

2



P-518-D  
WIRE DRIVE ASSEMBLY

Количество: 1

---

# P-518-A - INDEX OF SUB ASSEMBLIES



P-518-A  
INDEX OF SUB ASSEMBLIES

Количество: 1

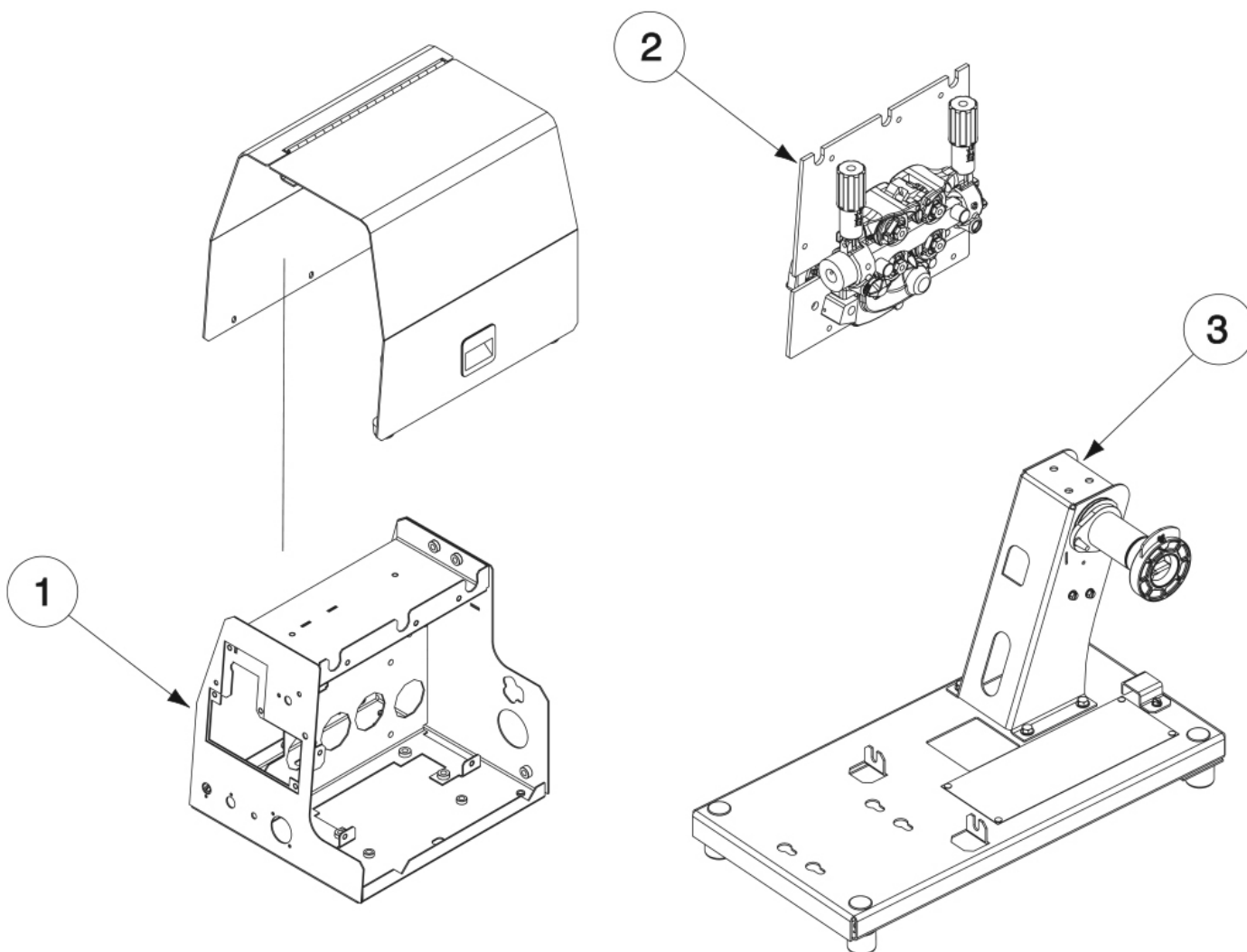

# P-518-A - INDEX OF SUB ASSEMBLIES

---



P-518-A  
INDEX OF SUB ASSEMBLIES

Количество: 1

Лист: P-518-A.jpg

<x-wc://file=P-518-A.jpg> / [P-518-A\\_en-US.jpg](P-518-A_en-US.jpg)

## P-518-B.2 - MISCELLANEOUS ITEMS

---



P-518-B.2  
MISCELLANEOUS ITEMS

Количество: 1

---



9ST15007-1  
INERT ARC NUT

Количество: 1

---



9ST15008  
BRASS NIPPLE

Количество: 1

---













9SS28198  
DECAL

Количество: 1











---













## P-518-C - CONTROL BOX/CENTER PANEL/CASE SHELL ASSE

		P-518-C CONTROL BOX/CENTER PANEL/CASE SHELL ASSE	Количество: 1
1		9SL12100-4 CENTER PANEL & CASE SHELL ASBLY	Количество: 1
2A		9ST14882-4 BUMPER	Количество: 4
2B		9SS9225-49 THREAD FORMING SCREW	Количество: 4
3		9ST12380-1 BUSHING	Количество: 2
		9ST12380-3 BUSHING	Количество: 1
5		9SS28276-2 CONTROL BOARD ASBLY	Количество: 1
5A		9ST9187-13 1/4-20 HLN	Количество: 4
		9SG4910-1 WIRING HARNESS	Количество: 1
6A		9SS12021-66 BOX RECEPTACLE SOLID SHELL	Заменена Количество: 1











## P-518-C - CONTROL BOX/CENTER PANEL/CASE SHELL ASSE

		P-518-C CONTROL BOX/CENTER PANEL/CASE SHELL ASSE		Количество: 1
		9ST10812-119 POTENTIOMETER	Заменена	Количество: 1
		9SS18280 POTENTIOMETER SPACER		Количество: 1
		9ST10082-27 #8-32 SEMS SCREW		Количество: 1
		9ST13657-4FA YELLOW LED		Количество: 1
		9SS25311-1 LED CONNECTOR & TERMINAL ASBLY		Количество: 1
6B		9SS8025-96 SELF TAPPING SCREW	Заменена	Количество: 6
6B		9SS8025-96 SELF TAPPING SCREW	Заменена	Количество: 2
7		9ST13637-6 DIODE-BRIDGE, 35A, 400V, F-W, 1-PH	Заменена	Количество: 1
		9ST9187-13 1/4-20 HLN		Количество: 1











## P-518-C - CONTROL BOX/CENTER PANEL/CASE SHELL ASSE

		P-518-C CONTROL BOX/CENTER PANEL/CASE SHELL ASSE	Количество: 1
8		9SM17294-8 12 VDC SOLENOID VALVE ASSEMBLY	Заменена Количество: 1
		9SS9262-149 PLAIN WASHER	Количество: 1
		9ST14370-1 CONDUIT LOCKNUT	Количество: 1
9A		9ST10642-267 FLEX TUBE	Количество: 1
9B		9ST13777-8 HOSE CLAMP	Количество: 2
10		9ST10800-38 SWITCH TOGGLE	Заменена Количество: 1
11		9ST10800-49 TOGGLE SWITCH	Количество: 1
12		9ST10491 KNOB	Количество: 1
12		9SM22778-2 KNOB, 1.5 IN	Количество: 1











## P-518-C - CONTROL BOX/CENTER PANEL/CASE SHELL ASSE

		P-518-C CONTROL BOX/CENTER PANEL/CASE SHELL ASSE	Количество: 1
13A		9SS25706 TIMER KIT PANEL	Количество: 1
13B		9SCF000371 #10-24 X .50 HHCS	Количество: 2
14A		9SS25707 REMOTE KIT PANEL	Количество: 1
14B		9SCF000371 #10-24 X .50 HHCS	Количество: 2
15A		9SM18947-1 BUSHING	Количество: 1
15B		9ST13483-37 O RING	Количество: 1
19A		9SL12095 WRAPAROUND	Количество: 1
19B		9SCF000371 #10-24 X .50 HHCS	Количество: 5
20A		9SL12097 DOOR AND HINGE ASBLY	Количество: 1

## P-518-C - CONTROL BOX/CENTER PANEL/CASE SHELL ASSE

		P-518-C CONTROL BOX/CENTER PANEL/CASE SHELL ASSE	Количество: 1
		9SCF000371 #10-24 X .50 HHCS	Количество: 3
21A		9SM22254 CONTROL CABLE ASSEMBLY	Количество: 1
		9ST14370-2 CONDUIT LOCKNUT	Количество: 1
		9SS8025-96 SELF TAPPING SCREW	Заменена Количество: 4
21D		9SS26587-3 CONTROL BOX PANEL	Количество: 1
22A		9SS23093-1 LED LENS	Заменена Количество: 1
22B		9SS23094-1 LED RETAINER	Заменена Количество: 1
23		9SS21033-1 DOOR LATCH	Количество: 1
		9SCF000040 5/16-18X.75HHCS	Количество: 4

## P-518-C - CONTROL BOX/CENTER PANEL/CASE SHELL ASSE

		P-518-C CONTROL BOX/CENTER PANEL/CASE SHELL ASSE	Количество: 1
		9SE106A-3 LOCK WASHER (5/16)	Количество: 4
		9SS9262-121 PLAIN WASHER	Количество: 4
25		9SS27368-2 DECAL - 7IN LINCOLN LOGO	Количество: 2
26		9SM20411-3 DECAL DOOR	Количество: 1
27A		9SL15259 NAMEPLATE	Количество: 1
		9SL15259 NAMEPLATE	Количество: 1
27D		9SL15259 NAMEPLATE	Количество: 1
27E		9SL15259 NAMEPLATE	Количество: 1
27F		9SL15259 NAMEPLATE	Количество: 1

## P-518-C - CONTROL BOX/CENTER PANEL/CASE SHELL ASSE

---



P-518-C  
CONTROL BOX/CENTER PANEL/CASE SHELL ASSE

Количество: 1

---

27H



9SL15259  
NAMEPLATE

Количество: 1

---

32A



9SS25836-1  
WARNING DECAL

Количество: 1



9SS25815-2  
WARNING DECAL

Количество: 1



9SL12146-3  
WIRING DIAGRAM

Количество: 1

---

# P-518-C - CONTROL BOX/CENTER PANEL/CASE SHELL ASSE



P-518-C

CONTROL BOX/CENTER PANEL/CASE SHELL ASSE

Количество: 1

\*Part #21F original harness 9SG4910  
now requires replacement parts  
9SG4910-1 AND 9SM22256.

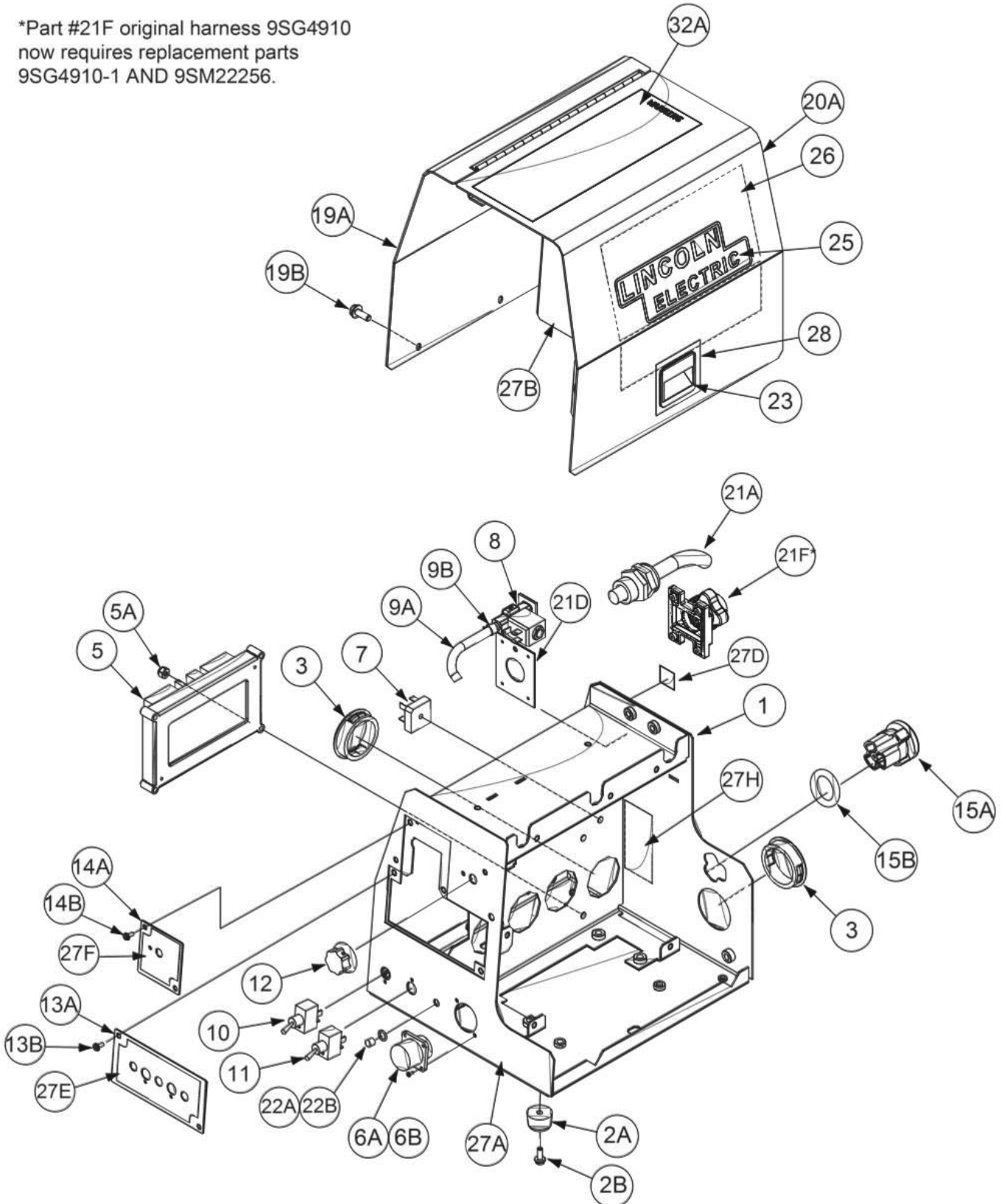



# P-518-C - CONTROL BOX/CENTER PANEL/CASE SHELL ASSE

---













P-518-C  
CONTROL BOX/CENTER PANEL/CASE SHELL ASSE

Количество: 1











Лист: P-518-C

<x-wc://file=0000125544.jpg> / [0000125544\\_x.jpg](0000125544_x.jpg)











## P-518-D - WIRE DRIVE ASSEMBLY

		P-518-D WIRE DRIVE ASSEMBLY	Количество: 1
<hr/>			
		9SL12378-2 WIRE DRIVE ASBLY	Заменена Количество: 1
1		9SL12091-1 GEARBOX MOUNTING PANEL	Количество: 1
2		9SG4945-1 FEED PLATE ASBLY	Количество: 1
		9SL12283-1 IDLE ARM LEFT	Количество: 1
		9ST13942-14 DOWEL PIN	Количество: 1
		9SL12283-2 IDLE ARM RIGHT	Количество: 1
		9ST13942-14 DOWEL PIN	Количество: 1
2F		9SM19179-2 ADJUSTMENT ARM ASBLY	Количество: 2
		9ST9967-35 PIN	Количество: 2











## P-518-D - WIRE DRIVE ASSEMBLY

		<b>P-518-D</b> WIRE DRIVE ASSEMBLY	Количество: 1
2H		<b>9SM19611-4</b> CONNECTOR BAR	Количество: 1
2J		<b>9ST9447-112</b> SOCKET HEAD CAP SCREW	Количество: 1
2K		<b>9SS9262-167</b> PLAIN WASHER	Количество: 1
2L		<b>9SS9776-69</b> RETAINING RING	Количество: 1
		<b>9SS22672</b> WIRE GUIDE RETAINING PIN	Количество: 2
		<b>9SS25402</b> SHAFT	Количество: 5
		<b>9ST11862-64</b> SPRING	Количество: 1
3A		<b>9SCF000012</b> 1/4-20X.50HHCS	Количество: 4
3B		<b>9SE106A-2</b> LOCK WASHER	Количество: 4











## P-518-D - WIRE DRIVE ASSEMBLY

		P-518-D WIRE DRIVE ASSEMBLY	Количество: 1
3C		9SS9262-23 PLAIN WASHER	Количество: 4
4A		9SCF000021 1/2-13X1.00HHCS	Количество: 1
4B		9SE106A-15 LOCKWASHER	Количество: 1
4C		9SS9262-1 PLAIN WASHER	Количество: 1
5A		9SL12081-1 MOTOR GEARBOX	Заменена Количество: 1
		9SS24018-8 CONNECTOR,MOLEX,MINI,LDS,8-PIN	Количество: 1
		9SS24019-8 CONNECTOR,LOCKING POST,FOR 8-CAVITY	Количество: 1
5E		9SS24170-1 WOODRUFF KEY	Количество: 1
5F		9SS9776-27 RETAINING RING	Количество: 1

## P-518-D - WIRE DRIVE ASSEMBLY

		<b>P-518-D</b> WIRE DRIVE ASSEMBLY	Количество: 1
		<b>9SS28460</b> MOTOR BRUSH & BRUSH CAP	Количество: 1
		<b>9SE106A-2</b> LOCK WASHER	Количество: 3
		<b>9ST14731-18</b> M6 X 1.00 PPNHS	Количество: 3
<b>7A</b>		<b>9SM19870</b> DRIVE GEAR	Количество: 1
<b>7B</b>		<b>9SS25414</b> COLLAR	Количество: 1
<b>7C</b>		<b>9ST4291-A</b> LOCK WASHER	Количество: 1
<b>7D</b>		<b>9ST14731-47</b> METRIC SCREW	Количество: 1
<b>8A</b>		<b>9SM20399</b> GEAR COVER CASTING	Количество: 1
<b>8B</b>		<b>9SCF000012</b> 1/4-20X.50HHCS	Количество: 3

## P-518-D - WIRE DRIVE ASSEMBLY

		P-518-D WIRE DRIVE ASSEMBLY	Количество: 1
8C		9SE106A-2 LOCK WASHER	Количество: 3
9		9SS25638 DRIVE ROLL SHAFT ASSEMBLY	Заменена Количество: 4
9A		9SS25308 TWIST LOCK RING	Количество: 4
11		9SS25403 RETAINER	Количество: 5
12		9SM18103-2 WIRE GUIDE-INNER	Количество: 1
		KP1696-1 DRIVE ROLL KIT, 035-045, 0.9-1.2MM	Количество: 4
14		KP2071-1 WIRE GUIDE ASBLY, OUTER, 4 ROLL	Заменена Количество: 1
15		9SS22905-2 GUN ADAPTER ASSEMBLY	Количество: 1
16		9ST13858 MOLDED HAND SCREW	Количество: 1

## P-518-D - WIRE DRIVE ASSEMBLY

---



P-518-D  
WIRE DRIVE ASSEMBLY

Количество: 1

---

17



9SS11604-21  
SET SCREW

Количество: 1

---

18



9SM18946  
BALL HOUSING

Количество: 1

---

19



9SS31815  
DRIVE HUB BEARING ASBLY

Заменена

Количество: 1

---

34



9SS25890-1  
DECAL, PRESSURE ARM

Количество: 1

---

35



9SS25815  
WARNING DECAL

Количество: 1

---

# P-518-D - WIRE DRIVE ASSEMBLY



P-518-D  
WIRE DRIVE ASSEMBLY

Количество: 1

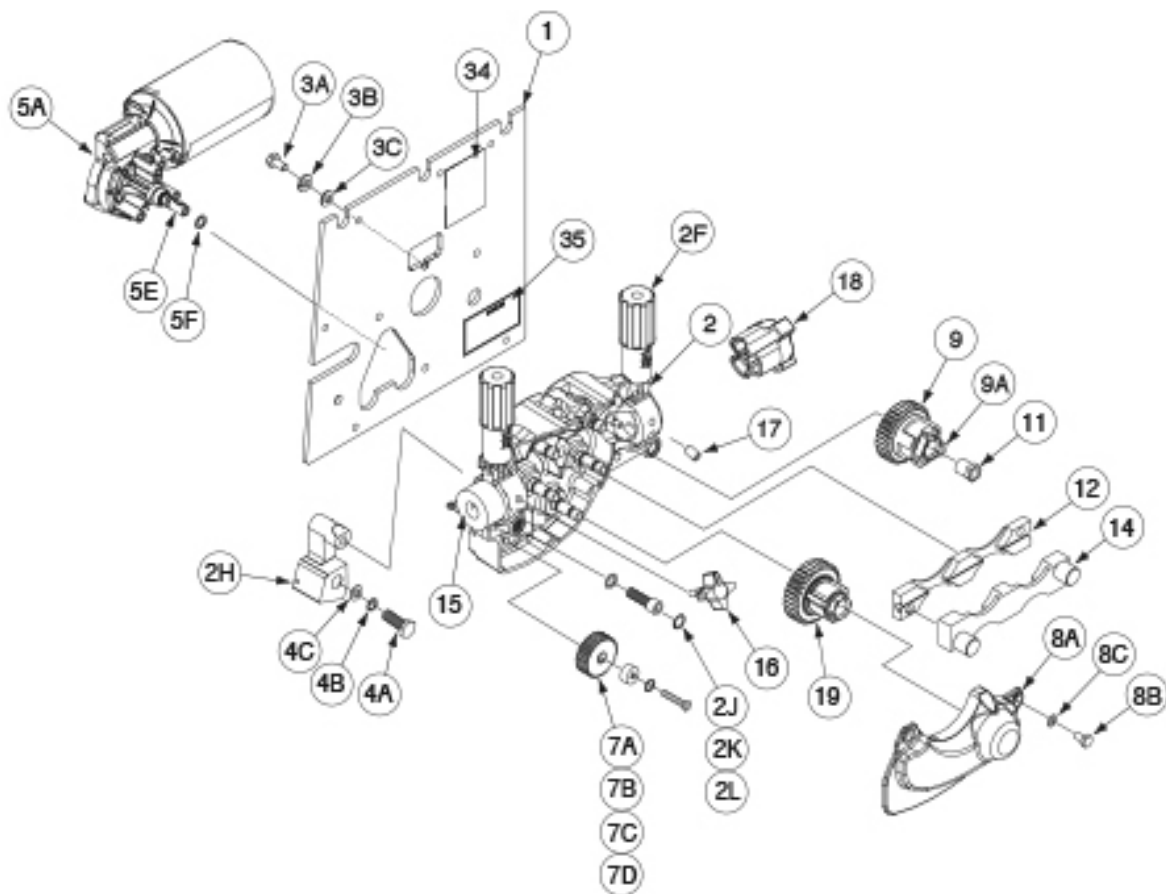



# P-518-D - WIRE DRIVE ASSEMBLY

---



P-518-D  
WIRE DRIVE ASSEMBLY

Количество: 1

Лист: P-518-D.jpg

<x-wc://file=P-518-D.jpg> / [P-518-D\\_en-US.jpg](x-wc://file=P-518-D_en-US.jpg)