

# Book Print











This page intentionally left blank

# Contents

|  |    |
|--|----|
| P-984-A - INDEX OF SUB ASSEMBLIES .....  | 5  |
| P-984-B.2 - MISCELLANEOUS ITEMS .....    | 8  |
| P-984-C - CASE FRONT ASSEMBLY.....       | 10 |
| P-984-D - BASE AND CENTER ASSEMBLY ..... | 16 |
| P-984-E - HEAT SINK ASSEMBLY.....        | 23 |
| P-984-F - MID SHELF ASSEMBLY.....        | 31 |
| P-984-G - TOP SHELF ASSEMBLY .....       | 37 |
| P-984-H - CASE BACK ASSEMBLY.....        | 41 |
| P-984-J - WRAPAROUND .....               | 47 |



## P-984-A - INDEX OF SUB ASSEMBLIES

|  |   |  |               |
|--|---|--|---------------|
|  |    | <b>P-984-A</b><br>INDEX OF SUB ASSEMBLIES  | Количество: 1 |
|  |    | <b>P-984-B.2</b><br>MISCELLANEOUS ITEMS    | Количество: 1 |
| 1  |    | <b>P-984-C</b><br>CASE FRONT ASSEMBLY      | Количество: 1 |
| 2  |    | <b>P-984-D</b><br>BASE AND CENTER ASSEMBLY | Количество: 1 |
| 3  |   | <b>P-984-E</b><br>HEAT SINK ASSEMBLY       | Количество: 1 |
| 4  |  | <b>P-984-F</b><br>MID SHELF ASSEMBLY       | Количество: 1 |
| 5  |  | <b>P-984-G</b><br>TOP SHELF ASSEMBLY       | Количество: 1 |
| 6  |  | <b>P-984-H</b><br>CASE BACK ASSEMBLY       | Количество: 1 |
| 7  |  | <b>P-984-J</b><br>WRAPAROUND               | Количество: 1 |

# P-984-A - INDEX OF SUB ASSEMBLIES



P-984-A  
INDEX OF SUB ASSEMBLIES

Количество: 1

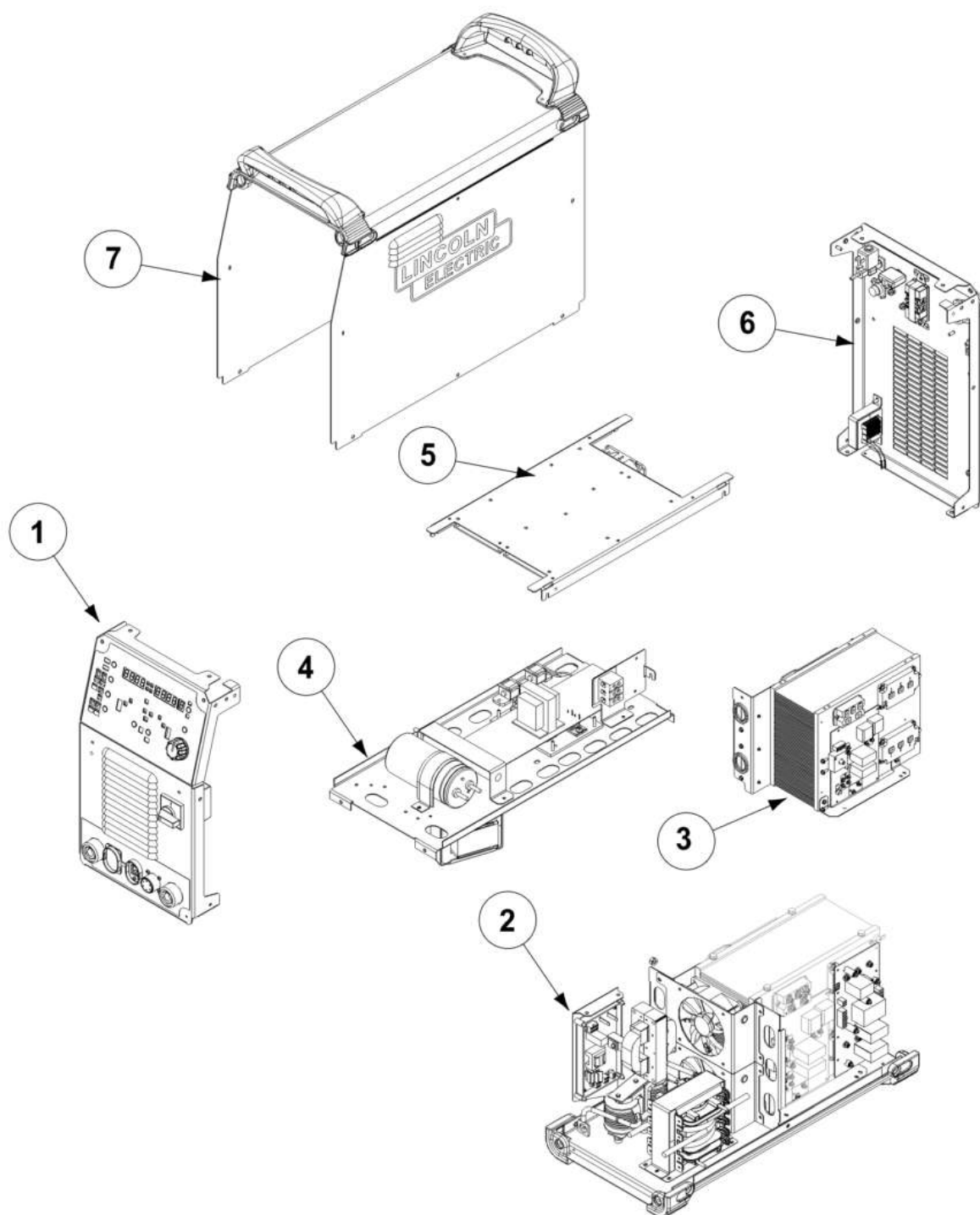

# P-984-A - INDEX OF SUB ASSEMBLIES

---













P-984-A  
INDEX OF SUB ASSEMBLIES

Количество: 1

Лист: P-984-A

[x-wc://file=0000151964.jpg / 0000151964\\_x.jpg](x-wc://file=0000151964.jpg / 0000151964_x.jpg)

## P-984-B.2 - MISCELLANEOUS ITEMS

|  |   |   |                           |
|--|---|---|---------------------------|
|  |    | P-984-B.2<br>MISCELLANEOUS ITEMS                | Количество: 1             |
| <hr/>  |   |   |                           |
|  |    | 9ST10642-209<br>FLEX TUBE                       | Заменена<br>Количество: 1 |
| <hr/>  |   |   |                           |
|  |    | 9SS20710-6<br>HOSE CLAMP                        | Количество: 2             |
| <hr/>  |   |   |                           |
|  |    | K1622-5<br>TWIST-MATE ADAPTER ASBLY             | Количество: 1             |
| <hr/>  |   |   |                           |
|  |   | K3950-1<br>COOL ARC 47                          | Количество: 1             |
| <hr/>  |   |   |                           |
|  |  | K4168-2<br>Water Cooled 20H-320-25R - K4168-2   | Количество: 1             |
| <hr/>  |   |   |                           |
|  |  | K3949-1<br>TIG Inverter Cart - K3949-1          | Количество: 1             |
| <hr/>  |   |   |                           |
|  |  | K918-4<br>HEAVY DUTY 25' ZIPPER COVER           | Количество: 1             |
| <hr/>  |   |   |                           |
|  |  | 3100211<br>FLOW/REG355-2AR-58010                | Количество: 1             |
| <hr/>  |   |   |                           |
|  |  | KP510<br>PARTS KIT FOR PTW-20 & PTW-250 TORCHES | Количество: 1             |



## P-984-B.2 - MISCELLANEOUS ITEMS

---



P-984-B.2  
MISCELLANEOUS ITEMS

Количество: 1













KP509  
PARTS KIT FOR PTW-18 PTA-26 & PTW-350











Количество: 1

---











## P-984-C - CASE FRONT ASSEMBLY

|  |   |  |               |
|--|---|--|---------------|
|  |    | <b>P-984-C</b><br>CASE FRONT ASSEMBLY      | Количество: 1 |
|  |    | <b>9SG8661</b><br>CASE FRONT ASSEMBLY      | Количество: 1 |
| 1  |    | <b>9SG7459</b><br>CASE FRONT               | Количество: 1 |
| 2  |    | <b>9SS29828-1</b><br>FOAM                  | Количество: 1 |
| 3  |   | <b>9SS29828-2</b><br>FOAM                  | Количество: 1 |
| 4  |  | <b>9SS29828-3</b><br>FOAM                  | Количество: 1 |
| 5  |  | <b>9SS29828-4</b><br>FOAM                  | Количество: 1 |
| 6A   |  | <b>9SG8668-1</b><br>UI P.C. BOARD ASSEMBLY | Количество: 1 |
| 6B   |  | <b>9SS19300-7</b><br>P.C. BOARD SUPPORT    | Количество: 3 |
|  |  | <b>9SCF000337</b><br>#6-32X.375PPNHS       | Количество: 4 |

## P-984-C - CASE FRONT ASSEMBLY

|  |   |                                       |                           |
|--|---|---------------------------------------|---------------------------|
|  |    | P-984-C<br>CASE FRONT ASSEMBLY        | Количество: 1             |
|  |    | 9SE106A-13<br>LOCK WASHER             | Количество: 4             |
| 7  |    | 9SS29667<br>PC BOARD STANDOFF         | Количество: 2             |
| 8A   |    | 9SG8670-1<br>MAIN CONTROL PC BD ASBLY | Количество: 1             |
|  |   | 9SCF000337<br>#6-32X.375PPNHS         | Количество: 2             |
|  |  | 9SE106A-13<br>LOCK WASHER             | Количество: 2             |
| 9  |  | 9SL16553<br>DECAL                     | Количество: 1             |
| 10A  |  | 9SM22444<br>ETHERNET COVER            | Количество: 1             |
| 10B  |  | 9SS8025-96<br>SELF TAPPING SCREW      | Заменена<br>Количество: 2 |
| 11   |  | 9SS29508<br>TWIST MATE RECEPTACLE     | Количество: 1             |

## P-984-C - CASE FRONT ASSEMBLY

|  |   |   |          |               |
|--|---|---|----------|---------------|
|  |    | P-984-C<br>CASE FRONT ASSEMBLY                  |          | Количество: 1 |
| 12   |    | 9SS29509<br>TWIST MATE RECEPTACLE WITH AIR PASS |          | Количество: 1 |
|  |    | 9SS18250-1030<br>PLUG & LEAD ASSEMBLY           |          | Количество: 1 |
| 13A  |    | 9SS12021-68<br>CONNECTOR                        | Заменена | Количество: 1 |
| 13B  |   | 9SS8025-96<br>SELF TAPPING SCREW                | Заменена | Количество: 4 |
| 13C  |  | 9SS17062-10<br>AMPHENOL CAP                     | Заменена | Количество: 1 |
| 14   |  | 9SS18250-1029<br>PLUG & LEAD ASSEMBLY           |          | Количество: 1 |
| 15   |  | 9SM22778-2<br>KNOB, 1.5 IN                      |          | Количество: 1 |
| 15A  |  | 9ST14034-4<br>FELT WASHER                       |          | Количество: 1 |
|  |  | 9SS9225-99<br>SELF TAPPING SCREW                |          | Количество: 4 |

## P-984-C - CASE FRONT ASSEMBLY

---



P-984-C  
CASE FRONT ASSEMBLY

Количество: 1

---

17



9SS29541-1  
POWER SWITCH REWORK

Количество: 1

---

18



9SG7626-1  
NAMEPLATE

Количество: 1



9SS18250-1026  
PLUG & LEAD ASSEMBLY

Количество: 1

---

# P-984-C - CASE FRONT ASSEMBLY



P-984-C  
CASE FRONT ASSEMBLY

Количество: 1

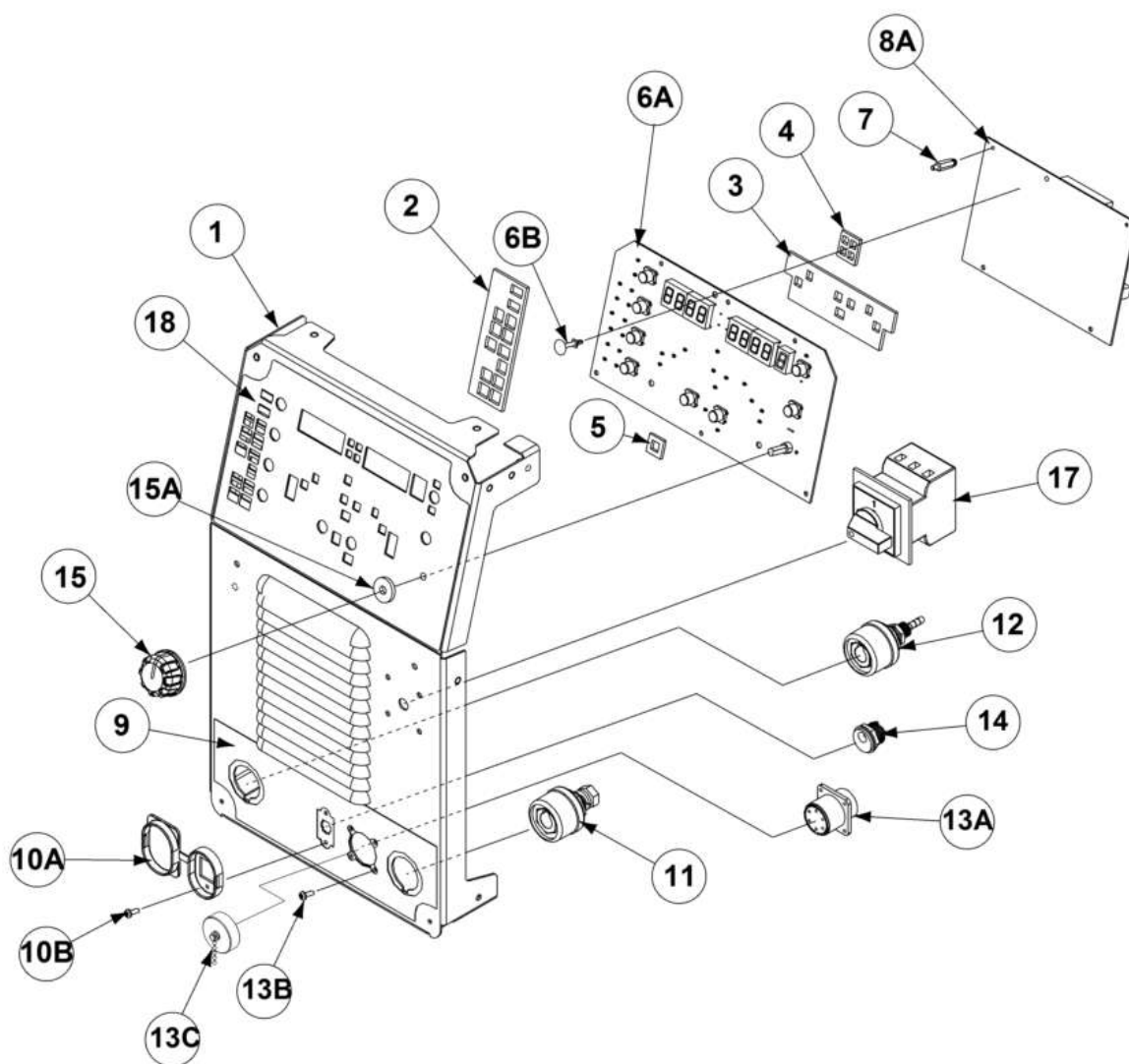

# P-984-C - CASE FRONT ASSEMBLY

---













P-984-C  
CASE FRONT ASSEMBLY

Количество: 1

Лист: P-984-C.jpg











[x-wc://file=P-984-C.jpg / P-984-C\\_en-US.jpg](#)

## P-984-D - BASE AND CENTER ASSEMBLY











|  |   |  |               |
|--|---|--|---------------|
|  |    | <b>P-984-D</b><br>BASE AND CENTER ASSEMBLY | Количество: 1 |
|  |    | <b>9SG8684</b><br>BASE AND CENTER ASSEMBLY | Количество: 1 |
|  |    | <b>9SM25764</b><br>BASE ASSEMBLY           | Количество: 1 |
| <b>1B</b>  |    | <b>9SG8665</b><br>BOTTOM COVER             | Количество: 1 |
| <b>1C</b>  |  | <b>9SS28070</b><br>QUICK LOCK FOOT         | Количество: 4 |
| <b>1D</b>  |  | <b>9SCF000012</b><br>1/4-20X.50HHCS        | Количество: 4 |
| <b>1E</b>  |  | <b>9SE106A-2</b><br>LOCK WASHER            | Количество: 4 |
| <b>1F</b>  |  | <b>9SS29507</b><br>CORNER CAP              | Количество: 4 |
| <b>1G</b>  |  | <b>9SS9225-100</b><br>#10-24X.75 SCREW     | Количество: 4 |
| <b>1H</b>  |  | <b>9SS9262-184</b><br>PLAIN WASHER         | Количество: 4 |













## P-984-D - BASE AND CENTER ASSEMBLY

|  |   |  |               |
|--|---|--|---------------|
|  |    | <b>P-984-D</b><br>BASE AND CENTER ASSEMBLY           | Количество: 1 |
| 1J   |    | <b>9SM25069</b><br>BASE BRACKET                      | Количество: 2 |
| 1K   |    | <b>9ST9187-13</b><br>1/4-20 HLN                      | Количество: 8 |
|  |    | <b>9SL17037</b><br>BOTTOM SHELF/TRANSFORMER ASSEMBLY | Количество: 1 |
| 2B   |   | <b>9SG8666</b><br>BOTTOM SHELF                       | Количество: 1 |
| 2C   |  | <b>9SG7524</b><br>HIGH FREQUENCY TRANSFORMER         | Количество: 1 |
| 2E   |  | <b>9SG7523</b><br>TRANSFORMER                        | Количество: 1 |
| 2F   |  | <b>9ST9187-13</b><br>1/4-20 HLN                      | Количество: 4 |
| 2G   |  | <b>9SCF000010</b><br>#10-24HN-4265                   | Количество: 2 |
|  |  | <b>9SS9225-99</b><br>SELF TAPPING SCREW              | Количество: 2 |

## P-984-D - BASE AND CENTER ASSEMBLY

|  |   |   |                |
|--|---|---|----------------|
|  |    | <b>P-984-D</b><br>BASE AND CENTER ASSEMBLY          | Количество: 1  |
|  |    | <b>9SS9225-99</b><br>SELF TAPPING SCREW             | Количество: 4  |
| <b>4A</b>  |    | <b>9SM24752-1</b><br>RIGHT SIDE BAFFLE              | Количество: 1  |
| <b>4B</b>  |    | <b>9SS9225-99</b><br>SELF TAPPING SCREW             | Количество: 2  |
| <b>5A</b>  |   | <b>9SM25078</b><br>FAN ASBLY                        | Количество: 2  |
| <b>5B</b>  |  | <b>9SM24748</b><br>MIDDLE FAN BRACKET               | Количество: 2  |
| <b>5C</b>  |  | <b>9SS9225-99</b><br>SELF TAPPING SCREW             | Количество: 16 |
| <b>5D</b>  |  | <b>9ST12380-4</b><br>BUSHING                        | Количество: 2  |
| <b>6</b>   |  | <b>9SS29543</b><br>GROMMET                          | Количество: 5  |
| <b>7</b>   |  | <b>9SL16392-1</b><br>BUCK BOOST P.C. BOARD ASSEMBLY | Количество: 1  |

## P-984-D - BASE AND CENTER ASSEMBLY

|  |   |  |                           |
|--|---|--|---------------------------|
|  |    | P-984-D<br>BASE AND CENTER ASSEMBLY      | Количество: 1             |
| 8  |    | 9SS29965-3<br>METRIC SEMS SCREW          | Количество: 6             |
| 9A   |    | 9SM25058<br>HIGH FREQUENCY BOARD BRACKET | Количество: 1             |
| 9B   |    | 9SG7372-3<br>HI FREQUENCY PC BD ASBLY    | Заменена<br>Количество: 1 |
| 9C   |   | 9ST9187-13<br>1/4-20 HLN                 | Количество: 4             |
| 9D   |  | 9SS9225-99<br>SELF TAPPING SCREW         | Количество: 3             |
| 10A  |  | 9SS29537-4<br>BUS BAR                    | Количество: 1             |
|  |  | 9SS25930-8<br>M6-1.00 TORX HEAD SCREW    | Количество: 2             |
| 11A  |  | 9SM24767<br>OUTPUT CHOKE                 | Количество: 1             |
|  |  | 9SS9225-99<br>SELF TAPPING SCREW         | Количество: 2             |

## P-984-D - BASE AND CENTER ASSEMBLY

---



P-984-D  
BASE AND CENTER ASSEMBLY

Количество: 1

---



9SS18250-1053  
PLUG & LEAD ASSEMBLY

Количество: 1

---



9SS18250-1037  
PLUG & LEAD ASSEMBLY

Количество: 1

---

# P-984-D - BASE AND CENTER ASSEMBLY



P-984-D  
BASE AND CENTER ASSEMBLY

Количество: 1

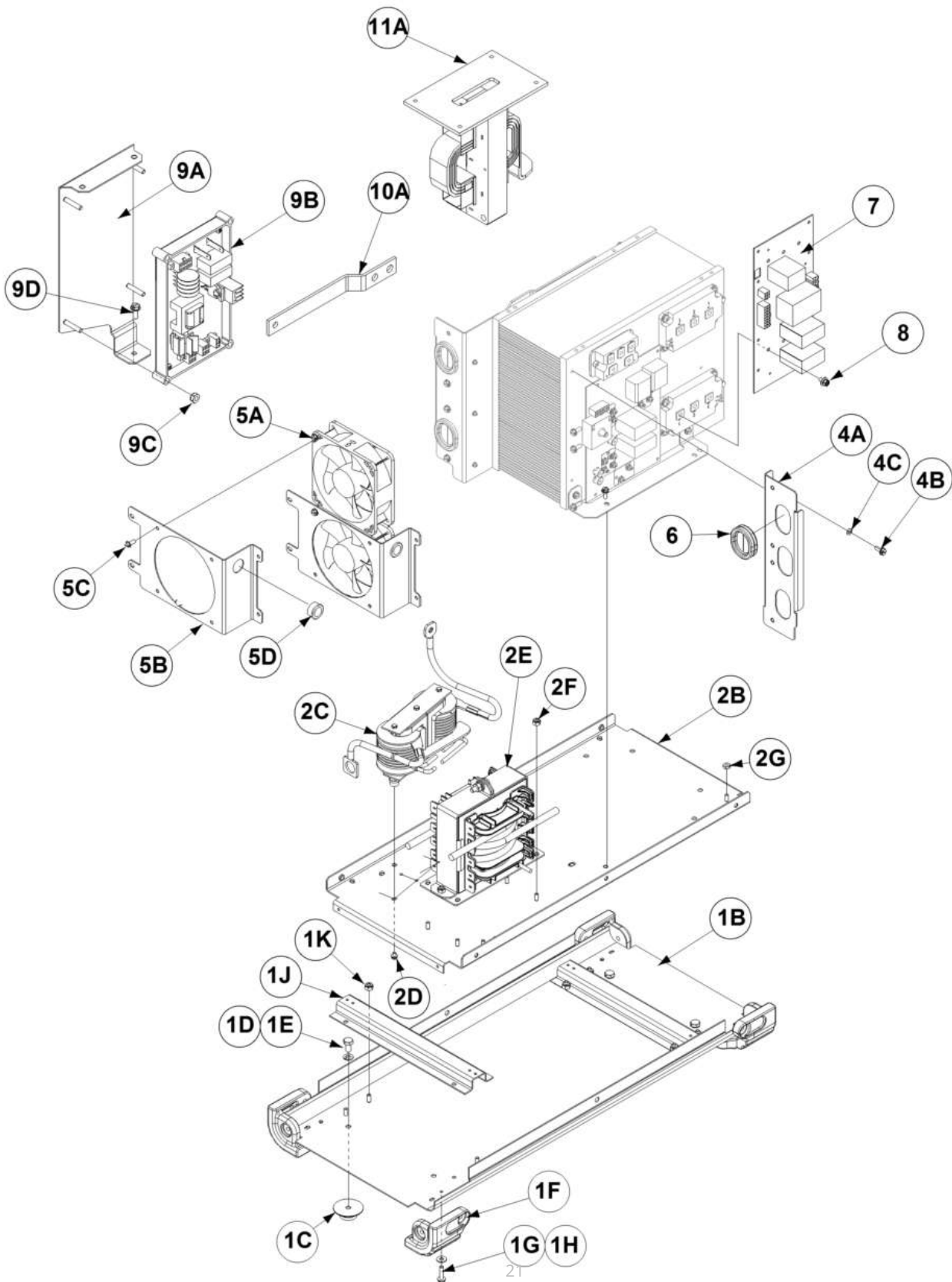

# P-984-D - BASE AND CENTER ASSEMBLY

---













P-984-D  
BASE AND CENTER ASSEMBLY

Количество: 1











Лист: P-984-D.jpg

<x-wc://file=P-984-D.jpg> / [P-984-D\\_en-US.jpg](x-wc://file=P-984-D_en-US.jpg)

## P-984-E - HEAT SINK ASSEMBLY











|  |   |  |                |
|--|---|--|----------------|
|  |    | <b>P-984-E</b><br>HEAT SINK ASSEMBLY                   | Количество: 1  |
|  |    | <b>9SG8688</b><br>HEAT SINK ASSEMBLY                   | Количество: 1  |
| <b>4A</b>  |    | <b>9SG7686-1</b><br>HEAT SINK                          | Количество: 1  |
| <b>5A</b>  |    | <b>9SM24769-1</b><br>IGBT W/ULTRA FAST DIODE (SOT 227) | Количество: 4  |
| <b>5B</b>  |   | <b>9ST9447-87</b><br>SOCKET HEAD CAP SCREW             | Количество: 8  |
| <b>5C</b>  |  | <b>9SE106A-13</b><br>LOCK WASHER                       | Количество: 8  |
| <b>6A</b>  |  | <b>9SM24912-5</b><br>POWER RESISTOR                    | Количество: 5  |
| <b>6B</b>  |  | <b>9ST9447-87</b><br>SOCKET HEAD CAP SCREW             | Количество: 10 |
| <b>6C</b>  |  | <b>9SE106A-13</b><br>LOCK WASHER                       | Количество: 10 |
| <b>7A</b>  |  | <b>9SM24768-2</b><br>BOOST MODULE                      | Количество: 1  |

## P-984-E - HEAT SINK ASSEMBLY











|  |   |  |               |
|--|---|--|---------------|
|  |    | <b>P-984-E</b><br>HEAT SINK ASSEMBLY                   | Количество: 1 |
| 7B   |    | <b>9SS25930-5</b><br>TORX BUTTON HEAD SCREW #10-24X.62 | Количество: 4 |
| 8A   |    | <b>9SM24768-3</b><br>BUCK MODULE                       | Количество: 1 |
| 8B   |    | <b>9SS25930-5</b><br>TORX BUTTON HEAD SCREW #10-24X.62 | Количество: 4 |
| 9A   |   | <b>9SM15454-18</b><br>INPUT RECTIFIER MODULE           | Количество: 1 |
| 9B   |  | <b>9SS25930-5</b><br>TORX BUTTON HEAD SCREW #10-24X.62 | Количество: 2 |
| 10A  |  | <b>9SM24769-3</b><br>ISOTOP FULL BRIDGE DIODES 60A     | Количество: 1 |
| 10B  |  | <b>9ST9447-87</b><br>SOCKET HEAD CAP SCREW             | Количество: 2 |
| 10C  |  | <b>9SE106A-13</b><br>LOCK WASHER                       | Количество: 2 |
| 11A  |  | <b>9SM24769-2</b><br>ISOTOP PARALLEL DIODES            | Количество: 8 |













## P-984-E - HEAT SINK ASSEMBLY

|  |   |   |                           |
|--|---|---|---------------------------|
|  |    | P-984-E<br>HEAT SINK ASSEMBLY           | Количество: 1             |
| 11B  |    | 9ST9447-87<br>SOCKET HEAD CAP SCREW     | Количество: 16            |
| 11C  |    | 9SE106A-13<br>LOCK WASHER               | Количество: 16            |
| 12A  |    | 9SM24752-2<br>BAFFLE                    | Количество: 1             |
| 12B  |   | 9SS29667<br>PC BOARD STANDOFF           | Количество: 2             |
| 12C  |  | 9SS9225-99<br>SELF TAPPING SCREW        | Количество: 2             |
| 14A  |  | 9SM25754<br>HEAT SINK BRACKET           | Количество: 2             |
| 14B  |  | 9SS9225-99<br>SELF TAPPING SCREW        | Количество: 4             |
|  |  | 9SS30400<br>THERMISTOR ASBLY            | Количество: 2             |
| 16A  |  | 9SG8679-1<br>INVERTER P.C. BD. ASSEMBLY | Заменена<br>Количество: 1 |

## P-984-E - HEAT SINK ASSEMBLY

|  |   |  |                |
|--|---|--|----------------|
|  |    | <b>P-984-E</b><br>HEAT SINK ASSEMBLY                   | Количество: 1  |
|  |    | <b>9SS29965-6</b><br>METRIC SEMS SCREW                 | Количество: 18 |
| 17A  |    | <b>9SG7730-1</b><br>OUTPUT P.C. BD. ASSEMBLY           | Количество: 1  |
| 17B  |    | <b>9SS25930-5</b><br>TORX BUTTON HEAD SCREW #10-24X.62 | Количество: 4  |
| 17D  |   | <b>9SCF000337</b><br>#6-32X.375PPNHS                   | Количество: 2  |
| 17E  |  | <b>9SE106A-13</b><br>LOCK WASHER                       | Количество: 2  |
| 18A  |  | <b>9SS29537-1</b><br>BUS BAR                           | Количество: 1  |
| 18B  |  | <b>9SS29965-2</b><br>METRIC SEMS SCREW                 | Количество: 8  |
| 18C  |  | <b>9SS25930-8</b><br>M6-1.00 TORX HEAD SCREW           | Количество: 1  |
| 18D  |  | <b>9SE106A-2</b><br>LOCK WASHER                        | Количество: 1  |

## P-984-E - HEAT SINK ASSEMBLY

|  |   |  |                |
|--|---|--|----------------|
|  |    | <b>P-984-E</b><br>HEAT SINK ASSEMBLY           | Количество: 1  |
| 19A  |    | <b>9SS29537-2</b><br>BUS BAR                   | Количество: 1  |
| 19B  |    | <b>9SS29965-2</b><br>METRIC SEMS SCREW         | Количество: 8  |
| 19C  |    | <b>9SS25930-8</b><br>M6-1.00 TORX HEAD SCREW   | Количество: 1  |
| 19D  |   | <b>9SE106A-2</b><br>LOCK WASHER                | Количество: 1  |
| 20A  |  | <b>9SS29537-3</b><br>BUS BAR                   | Количество: 2  |
| 20B  |  | <b>9ST11827-23</b><br>CARRIAGE BOLT            | Количество: 2  |
| 20C  |  | <b>9SS29965-2</b><br>METRIC SEMS SCREW         | Количество: 16 |
|  |  | <b>9SS18250-1043</b><br>PLUG AND LEAD ASSEMBLY | Количество: 1  |
|  |  | <b>9SS18250-1028</b><br>PLUG & LEAD ASSEMBLY   | Количество: 2  |

## P-984-E - HEAT SINK ASSEMBLY

---



P-984-E  
HEAT SINK ASSEMBLY

Количество: 1



9SS18491-6  
MOV ASSEMBLY

Заменена

Количество: 1

---

# P-984-E - HEAT SINK ASSEMBLY



P-984-E  
HEAT SINK ASSEMBLY

Количество: 1

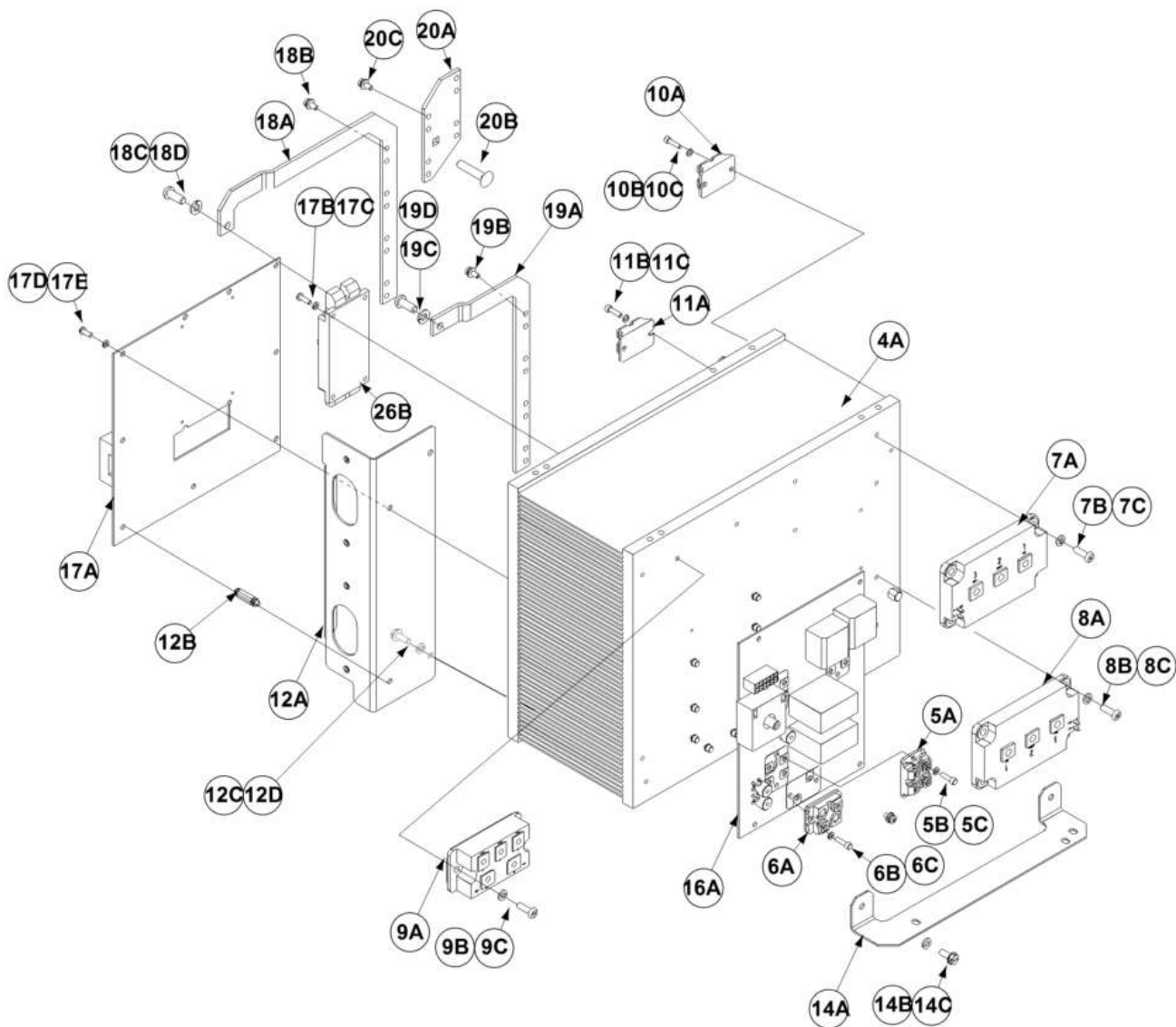

# P-984-E - HEAT SINK ASSEMBLY

---













P-984-E  
HEAT SINK ASSEMBLY

Количество: 1











Лист: P-984-E.jpg

[x-wc://file=P-984-E.jpg / P-984-E\\_en-US.jpg](#)

## P-984-F - MID SHELF ASSEMBLY











|  |   |                                 |               |
|--|---|---------------------------------|---------------|
|  |    | P-984-F<br>MID SHELF ASSEMBLY   | Количество: 1 |
|  |    | 9SG7856<br>MID SHELF ASSEMBLY   | Количество: 1 |
| 1  |    | 9SL16307<br>TOP SHELF           | Количество: 1 |
| 2A   |    | 9SM21489-3<br>INPUT CHOKE       | Количество: 1 |
| 2B   |   | 9SM21468<br>INPUT CHOKE BRACKET | Количество: 1 |
| 2C   |  | 9ST9187-13<br>1/4-20 HLN        | Количество: 2 |
| 3A   |  | 9ST12218-42<br>DOUBLER CHOKE    | Количество: 2 |
| 3B   |  | 9ST9187-13<br>1/4-20 HLN        | Количество: 4 |
| 4A   |  | 9SG7467-1<br>AUXILIARY BOARD    | Количество: 1 |
| 4B   |  | 9ST9187-13<br>1/4-20 HLN        | Количество: 4 |

## P-984-F - MID SHELF ASSEMBLY

|  |   |  |               |
|--|---|--|---------------|
|  |    | <b>P-984-F</b><br>MID SHELF ASSEMBLY     | Количество: 1 |
| 5  |    | <b>9SCF000010</b><br>#10-24HN-4265       | Количество: 3 |
| 6A   |    | <b>9SCF000012</b><br>1/4-20X.50HHCS      | Количество: 4 |
| 6B   |    | <b>9SE106A-2</b><br>LOCK WASHER          | Количество: 4 |
| 7  |   | <b>9SS29543</b><br>GROMMET               | Количество: 9 |
| 8A   |  | <b>9SS13490-249</b><br>CAPACITOR         | Количество: 1 |
| 8B   |  | <b>9SS29506</b><br>CAPACITOR MTG BRACKET | Количество: 1 |
| 8D   |  | <b>9SM25059</b><br>INSULATION            | Количество: 1 |
| 8E   |  | <b>9ST9187-13</b><br>1/4-20 HLN          | Количество: 1 |
| 9  |  | <b>9ST12380-8</b><br>GROMMET             | Количество: 2 |



## P-984-F - MID SHELF ASSEMBLY

|  |   |                                 |               |
|--|---|---------------------------------|---------------|
|  |    | P-984-F<br>MID SHELF ASSEMBLY   | Количество: 1 |
|  |    | 9SM25057<br>RESISTOR BRACKET    | Количество: 1 |
|  |    | 9ST9187-13<br>1/4-20 HLN        | Количество: 2 |
| 10C  |    | 9SS10404-147<br>RESISTOR        | Количество: 1 |
| 10D  |  | 9ST4479-A<br>INSULATING WASHER  | Количество: 2 |
| 10E  |  | 9SCF000191<br>#10-24 X 7.50 RHS | Количество: 1 |
| 10F  |  | 9SS9262-27<br>PLAIN WASHER      | Количество: 2 |
| 10H  |  | 9SCF000010<br>#10-24HN-4265     | Количество: 1 |
| 11   |  | 9SM24954<br>DISCONNECT PANEL    | Количество: 1 |
|  |  | 9ST9187-13<br>1/4-20 HLN        | Количество: 2 |

## P-984-F - MID SHELF ASSEMBLY

---



P-984-F  
MID SHELF ASSEMBLY

Количество: 1

---

11B



9SS20763-3  
TERMINAL BLOCK

Количество: 1

---



9ST9447-129  
#8-32 x .375 SHCS

Количество: 2

---



9SS18250-1032  
PLUG & LEAD ASSEMBLY

Количество: 1

---

# P-984-F - MID SHELF ASSEMBLY



P-984-F  
MID SHELF ASSEMBLY

Количество: 1

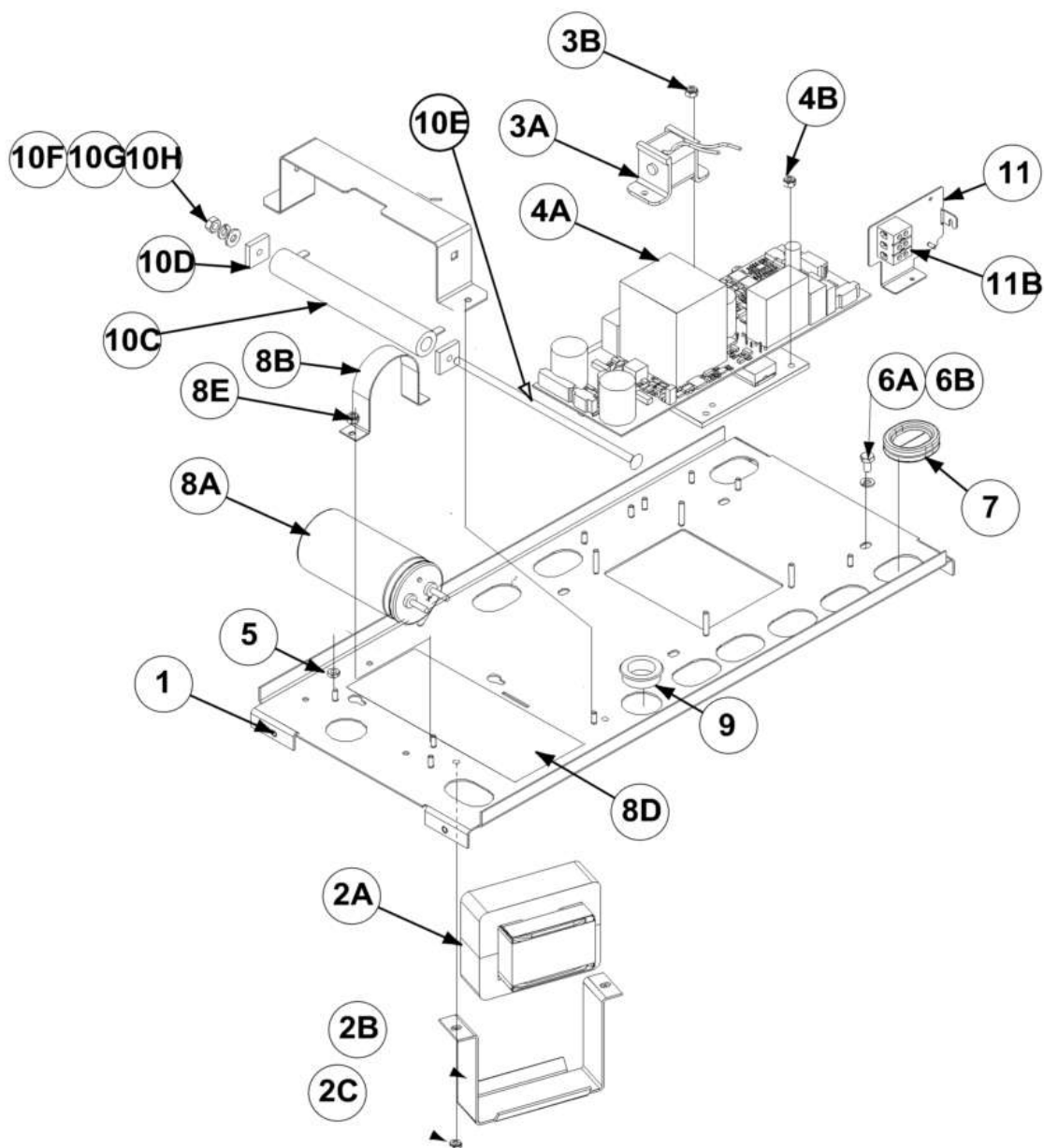

# P-984-F - MID SHELF ASSEMBLY

---













P-984-F  
MID SHELF ASSEMBLY

Количество: 1

Лист: P-984-F

<x-wc://file=0000014631.jpg> / [0000014631\\_x.jpg](0000014631_x.jpg)

## P-984-G - TOP SHELF ASSEMBLY

|  |   |  |                           |
|--|---|--|---------------------------|
|  |    | P-984-G<br>TOP SHELF ASSEMBLY                  | Количество: 1             |
|  |    | 9SL17036<br>TOP SHELF ASSEMBLY                 | Количество: 1             |
| 1  |    | 9SG7736<br>UPPER BOARD MOUNT                   | Количество: 1             |
| 2A   |    | 9SCF000010<br>#10-24HN-4265                    | Количество: 2             |
| 3A   |   | 9SM25079<br>FAN ASBLY                          | Количество: 1             |
| 3B   |  | 9SS9225-99<br>SELF TAPPING SCREW               | Количество: 3             |
| 4A   |  | 9SG7471-1<br>INPUT CONTROL P.C. BOARD ASSEMBLY | Количество: 1             |
| 4B   |  | 9SCF000337<br>#6-32X.375PPNHS                  | Количество: 6             |
| 4C   |  | 9SE106A-13<br>LOCK WASHER                      | Количество: 6             |
| 5A   |  | 9SG8675-1<br>INPUT POWER P.C. BOARD ASSEMBLY   | Заменена<br>Количество: 1 |

## P-984-G - TOP SHELF ASSEMBLY

---



P-984-G  
TOP SHELF ASSEMBLY

Количество: 1

---

5B



9SCF000337  
#6-32X.375PPNHS

Количество: 8

---

5C



9SE106A-13  
LOCK WASHER

Количество: 8



9SS18250-1040  
PLUG AND LEAD ASSEMBLY

Количество: 1

---

# P-984-G - TOP SHELF ASSEMBLY



P-984-G  
TOP SHELF ASSEMBLY

Количество: 1

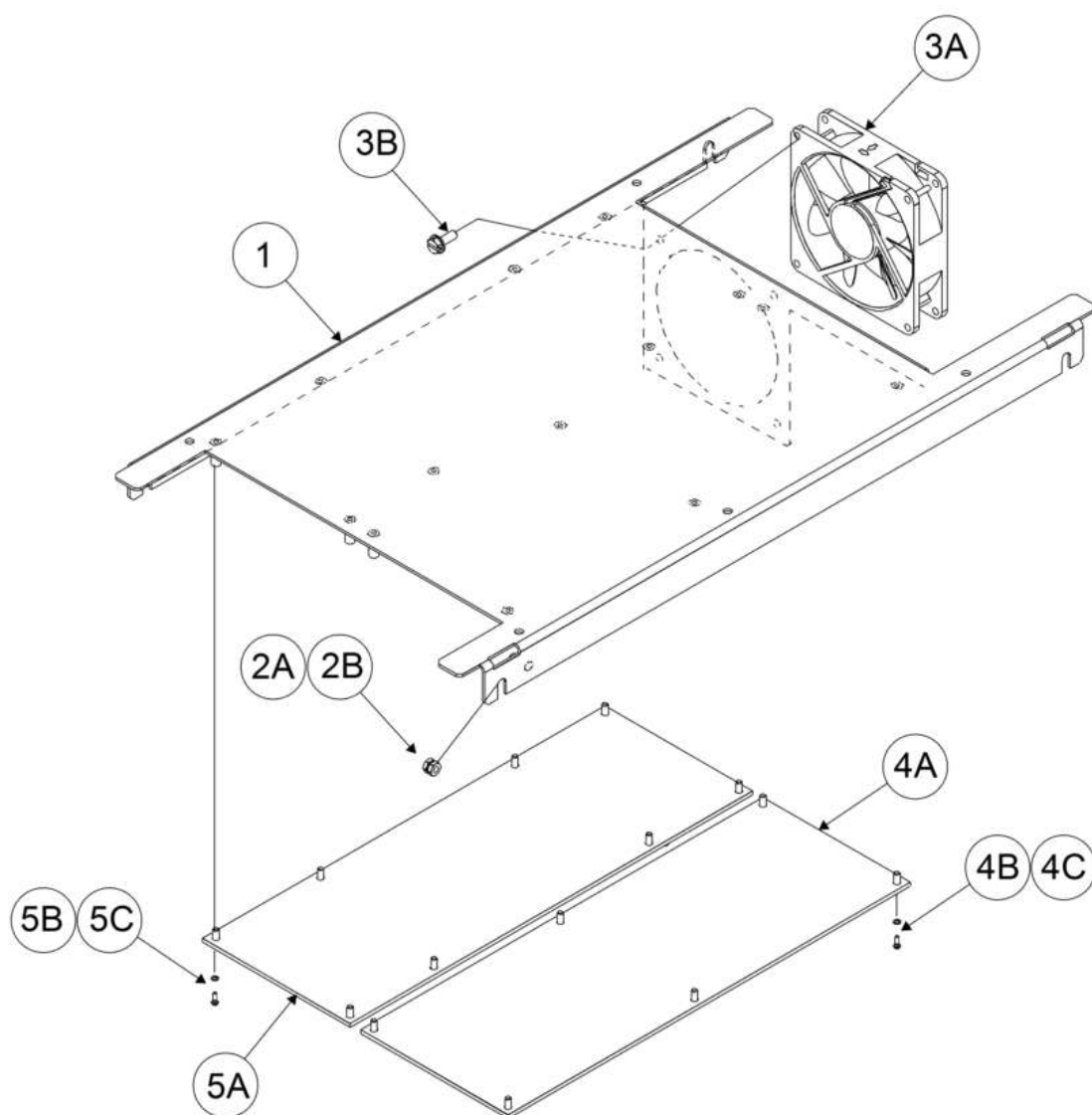

# P-984-G - TOP SHELF ASSEMBLY

---



P-984-G  
TOP SHELF ASSEMBLY











Количество: 1

Лист: P-984-G.jpg











[x-wc://file=P-984-G.jpg / P-984-G\\_en-US.jpg](#)













## P-984-H - CASE BACK ASSEMBLY

|  |   |                                     |                           |
|--|---|-------------------------------------|---------------------------|
|  |    | P-984-H<br>CASE BACK ASSEMBLY       | Количество: 1             |
|  |    | 9SG8662<br>CASE BACK ASSEMBLY       | Количество: 1             |
| 1  |    | 9SG8663<br>CASE BACK                | Количество: 1             |
| 2  |    | 9SL16553<br>DECAL                   | Количество: 1             |
| 3A   |   | 9SS20184<br>RECEPTACLE              | Количество: 1             |
| 3B   |  | 9SM16996<br>RECEPTACLE COVER        | Заменена<br>Количество: 1 |
| 3C   |  | 9SM22176<br>DECAL (115V RECEPTACLE) | Количество: 1             |
| 3D   |  | 9SS9225-100<br>#10-24X.75 SCREW     | Количество: 2             |
| 3E   |  | 9ST9187-13<br>1/4-20 HLN            | Количество: 2             |
|  |  | 9SS18250-1024<br>PLUG & LEAD ASBLY  | Количество: 1             |

## P-984-H - CASE BACK ASSEMBLY

|  |   |  |               |
|--|---|--|---------------|
|  |    | <b>P-984-H</b><br>CASE BACK ASSEMBLY         | Количество: 1 |
| 4A   |    | <b>9ST12287-20</b><br>CIRCUIT BREAKER        | Количество: 1 |
| 4B   |    | <b>9SS22061-3</b><br>SEALING BOOT            | Количество: 1 |
| 5A   |    | <b>9SS19999</b><br>CORD GRIP CONNECTOR       | Количество: 1 |
| 5B   |   | <b>9ST14370-3</b><br>CONDUIT LOCKNUT         | Количество: 1 |
| 6A   |  | <b>9SM17294-17</b><br>SOLENOID VALVE ASBLY   | Количество: 1 |
| 6B   |  | <b>9ST14370-1</b><br>CONDUIT LOCKNUT         | Количество: 1 |
| 6C   |  | <b>9SS9262-149</b><br>PLAIN WASHER           | Количество: 1 |
| 7A   |  | <b>9SM24732</b><br>BACKGROUND CHOKE ASSEMBLY | Количество: 1 |
| 7B   |  | <b>9SS29480</b><br>BACKGROUND CHOKE BRACKET  | Количество: 1 |

## P-984-H - CASE BACK ASSEMBLY

|  |   |  |                                  |
|--|---|--|----------------------------------|
|  |    | P-984-H<br>CASE BACK ASSEMBLY                      | Количество: 1                    |
| 7C   |    | 9ST9187-13<br>1/4-20 HLN                           | Количество: 2                    |
| 8  |    | 9ST13260-4<br>DECAL-EARTH GROUND CONN              | Количество: 1                    |
| 9  |    | 9SM25753<br>RATING PLATE                           | Количество: 1                    |
| 10A  |   | 9SCF000010<br>#10-24HN-4265                        | Количество: 4                    |
|  |  | <b>9SG7756</b><br>MAIN HARNESS                     | Количество: 1                    |
| 11A  |  | <b>9SS18657</b><br>SQUARE FLANGE FEMALE RECEPTACLE | Количество: 1                    |
| 11B  |  | 9SS8025-96<br>SELF TAPPING SCREW                   | <b>Заменена</b><br>Количество: 2 |
|  |  | 9SS18573-17<br>INPUT LEAD ASSEMBLY                 | Количество: 1                    |
|  |  | 9SS19316-7<br>TOROIDAL CORE                        | Количество: 1                    |

## P-984-H - CASE BACK ASSEMBLY

---



P-984-H  
CASE BACK ASSEMBLY

Количество: 1

---

13



9ST12563-10  
LEAD CLAMP

Количество: 1

---

# P-984-H - CASE BACK ASSEMBLY



P-984-H  
CASE BACK ASSEMBLY

Количество: 1

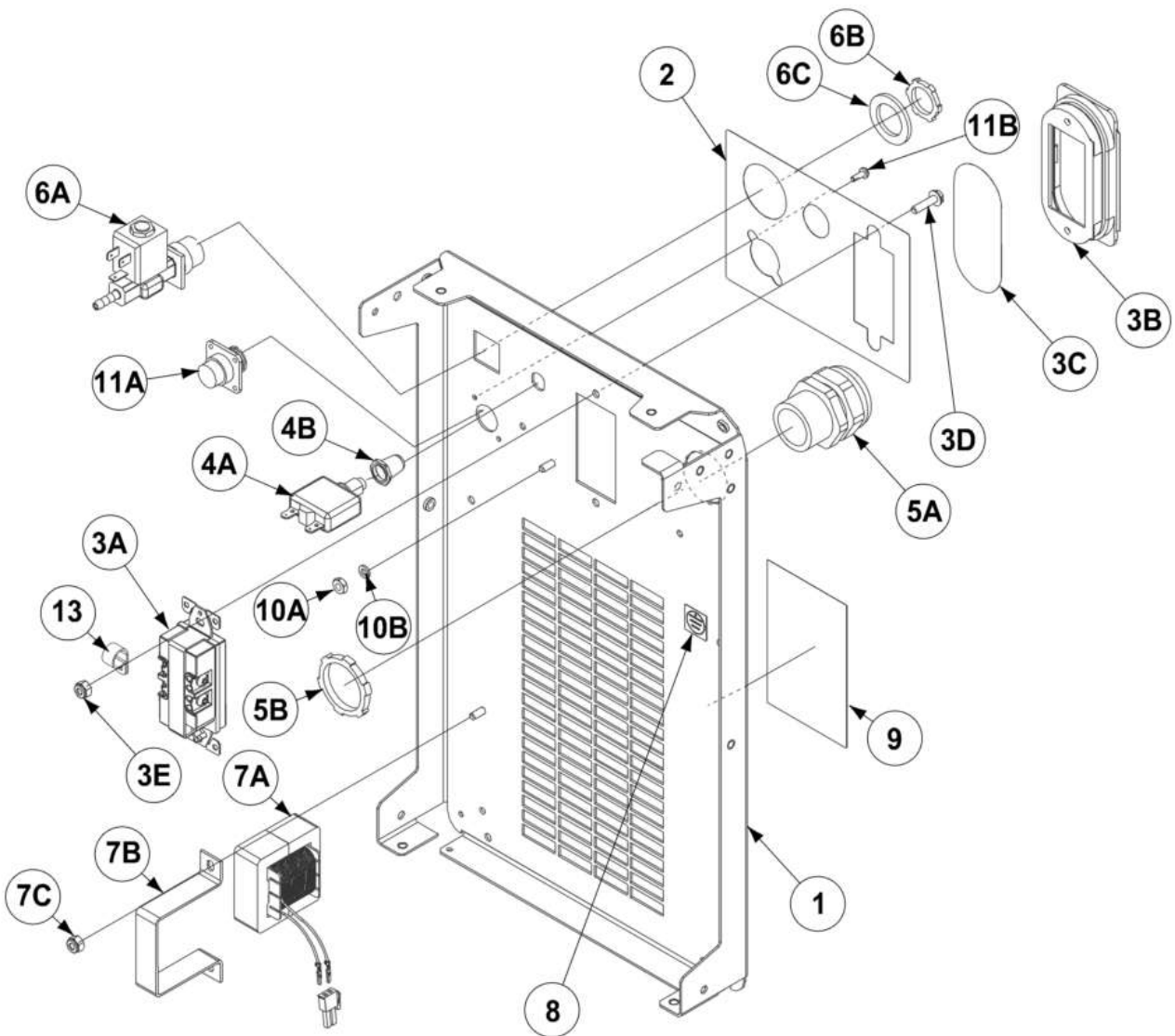

# P-984-H - CASE BACK ASSEMBLY

---













P-984-H  
CASE BACK ASSEMBLY

Количество: 1

Лист: P-984-H.jpg

<x-wc://file=P-984-H.jpg> / [P-984-H\\_en-US.jpg](P-984-H_en-US.jpg)

## P-984-J - WRAPAROUND

|  |   |  |                |
|--|---|--|----------------|
|  |    | P-984-J<br>WRAPAROUND                      | Количество: 1  |
| 1A   |    | 9SG8664<br>WRAPAROUND                      | Количество: 1  |
| 1B   |    | 9SS9225-99<br>SELF TAPPING SCREW           | Количество: 6  |
|  |    | 9SS9225-100<br>#10-24X.75 SCREW            | Количество: 4  |
|  |  | 9SS9262-184<br>PLAIN WASHER                | Количество: 4  |
| 2A   |  | 9SM24770<br>HANDLE                         | Количество: 2  |
| 2B   |  | 9SS9225-100<br>#10-24X.75 SCREW            | Количество: 16 |
| 2C   |  | 9SS9262-184<br>PLAIN WASHER                | Количество: 16 |
| 5  |  | 9SS27368-4<br>DECAL, LECO LOGO             | Количество: 2  |
| 6  |  | 9SL8064-1<br>WARNING LABEL (INTERNATIONAL) | Количество: 1  |

## P-984-J - WRAPAROUND

---



P-984-J  
WRAPAROUND

Количество: 1

---

7



9SS22127-2  
DECAL-WARRANTY

Количество: 1

---

8



9SS28039-2  
DECAL GREEN INITIATIVE

Количество: 1

---

9



9SG8664-1  
RIGHT CASE SIDE

Количество: 1

---



# P-984-J - WRAPAROUND



P-984-J  
WRAPAROUND

Количество: 1

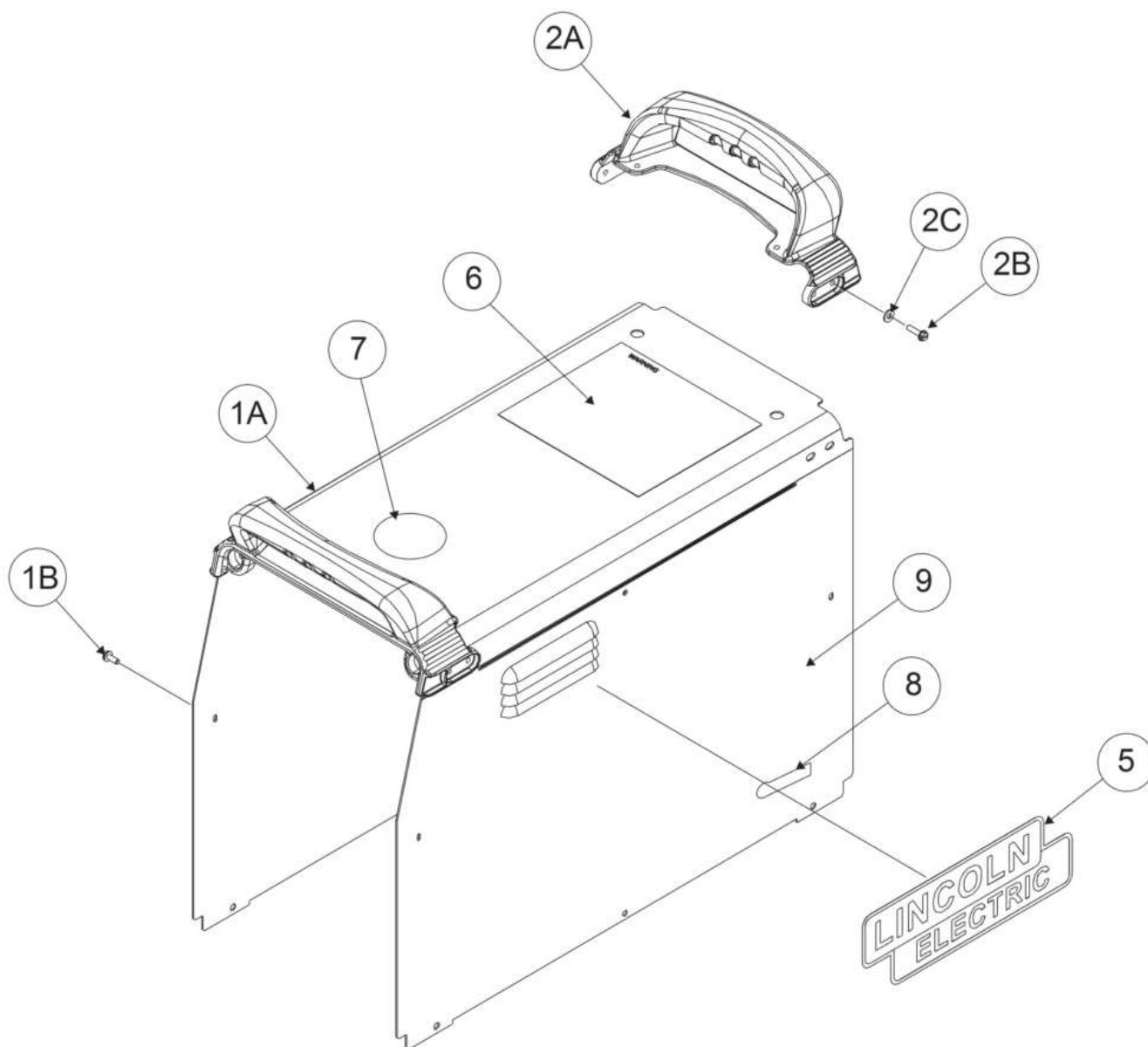

# P-984-J - WRAPAROUND

---



P-984-J  
WRAPAROUND

Количество: 1

Лист: P-984-J.jpg

[x-wc://file=P-984-J.jpg](#) / [P-984-J\\_en-US.jpg](#)